



ICS ice cleaning systems s.r.o.
Robotnícka 2192
01701 Považská Bystrica
Slovakia

+421 42 4261 135
support@ics-dryice.com
www.ics-dryice.com

Version: 24-01

Original Operations Manual

Blasting machine

IC-430

Content

1	Introduction and copyright.....	- 1 -
1.1	System identification.....	- 2 -
2	Safety instructions.....	- 2 -
2.1	Definitions of Responsible Persons.....	- 3 -
2.2	General safety guidelines.....	- 4 -
2.3	Symbols on the machine.....	- 5 -
2.4	Static Electricity.....	- 6 -
2.5	Explosive Hazard.....	- 6 -
3	Process description.....	- 7 -
4	Machine technical data.....	- 8 -
5	Setup and function.....	- 8 -
5.1	Unpacking the machine.....	- 8 -
5.2	Transport and storage.....	- 9 -
5.3	Machine illustrations and labels.....	- 9 -
5.4	Control panel.....	- 13 -
5.5	Device Grounding Procedure.....	- 14 -
5.6	Starting machine.....	- 14 -
5.7	Shutting down the machine.....	- 16 -
5.8	HMI panel.....	- 17 -
5.8.1	Main screen.....	- 17 -
5.8.2	Settings screen.....	- 18 -
5.8.3	HMI touch screen.....	- 18 -
5.8.4	Adjustment screens.....	- 19 -
6	Troubleshooting and maintenance.....	- 20 -
6.1	Preventive maintenance.....	- 20 -
6.1.1	Daily maintenance.....	- 20 -
6.1.2	Safety Mechanisms Check.....	- 20 -
6.1.3	1000 hours maintenance.....	- 21 -
6.2	Faults.....	- 21 -
7	Repair and Warranty.....	- 22 -
8	Technical schematics.....	- 23 -
8.1	Dimensional drawing.....	- 23 -
8.2	Electrical schematics.....	- 24 -
8.3	Pneumatic schematic.....	- 38 -
9	Liquidation.....	- 40 -
10	Certificates.....	- 41 -
10.1	Certificate STN EN ISO 9001:2016.....	- 41 -
10.2	ES DECLARATION OF CONFORMITY.....	- 42 -

1 Introduction and copyright

This operating manual explains the safe and defect-free usage of the IC-430 dry ice blasting equipment. Every person operating this equipment must have fully read and understood the instructions given in this manual before putting the equipment into operation. Please keep this manual safe and always at hand.

Failure to observe the procedures specified herein may lead to serious consequences both on the equipment and on its operators. The operator has to strictly observe the working procedures described herein. Any changes made to these work procedures have to be approved in writing by ICS Ice Cleaning Systems s.r.o.

The manufacturer of the equipment is not held responsible for damages caused to the system or generated by the system in the following cases:

- Improper handling.
- Failure to follow the operating instructions.
- Repairs by unauthorized personnel.
- Installation and replacement of non-original ICS parts.
- Inappropriate use.
- Operation by non-instructed personnel.

Any change in the operating procedure requires the written consent of the manufacturer of the IC-430:

ICS ice cleaning systems s.r.o.
Robotnícka 2192,
01701 Považská Bystrica
Slovakia

Phone: +421 (0)42 42 61 135

E-mail: info@ics-dryice.com

Copyright

The copyright to this operating instructions manual belongs to ICS Ice Cleaning Systems s.r.o.

This operating manual is intended for the operating and supervisory personnel. It contains regulations, illustrations and instructions, whose usage, fully or partially, by third parties is completely prohibited without an express written permission in this respect.

The illustrations are different equipment variants.

1.1 System identification

Machine identification plate location



EU identification plate

web: www.ics-dryice.com tel: +421 42 4261 135 email: info@ics-dryice.com			
Name: Dry ice blasting machine		Type: IC-430	
Ser. number:		Manuf. date:	
AC volts: 230V AC / 50 Hz		Weight: 124 kg	
Amps: 2,5 A		Pressure max: 16 bar	
SSCR: 10 kA		El. drawing number: 430-02	

UL identification plate

web: www.ics-dryice.com tel: +421 42 4261 135 email: info@ics-dryice.com			
Name: Dry ice blasting machine		Type: IC-430	
Ser. number:		Manuf. date:	
AC volts: 110V AC / 60 Hz		Weight: 275 lb	
Amps: 2,5 A		Pressure max: 230 psi	
SSCR: 10 kA		El. drawing number: 430-02	

2 Safety instructions

The safety guidelines delineated below are critical for ensuring the safety of operators and other involved individuals, as well as the secure operation of the equipment.

Security and Risk

The IC-430 is designed to comply with the EC Declaration of Conformity for Machinery. Therefore, using the machine does not pose a risk to the operator when the instructions in this manual are followed.

It is important that the operator follows the safety signs posted on the machine and the safety regulations described in this manual and that the operator reads and understands the contents of this manual before starting up the machine.

The user is obligated to operate the IC-430 only in perfect condition.

Unauthorized modifications and alterations affecting the security of the IC-430 are not permitted.

2.1 Definitions of Responsible Persons

Operator

An operator is an individual or a legal entity operating the blasting machine, or on whose premises the blasting machine is being operated. The operator must ensure that the device is utilised solely for the intended purpose, and in adherence with all safety guidelines provided in this operations manual. The operator must ensure that all users of the machine have read and understood the safety guidelines. The operator is responsible for scheduling and proper execution of regular safety checks. Adherence to national performance standards is strongly advised.

Qualified Professional

A qualified professional is an individual who is employed by the manufacturer, or an individual who meets the following criteria:

- Possesses a completed professional qualification that demonstrably proves their professional competence, such as an apprenticeship certificate or an equivalent credential.
- Has demonstrable work experience proving that the qualified professional possesses the necessary expertise. The qualified professional should be familiar with various potential indicators necessitating further examination, based e.g. on risk assessments or routine inspections.
- A qualified professional must have experience in performing the aforementioned tests, or similar tests. In addition, a qualified professional shall stay updated on the current technological advances pertinent to the tested equipment and assessed risks.

Operating Personnel

The dry ice blasting machine can only be operated by personnel who have completed the necessary operations training and proved their competence to operate the equipment to the designated representative of the operator. The operating personnel shall at all times use suitable PPE (protective clothing, safety shoes, safety glasses, gloves). Safety shoes must be worn at all times for safety reasons. The operating personnel must be familiarised with the operating instructions, which should be readily accessible to them at all times.

The operating personnel must:

- Read and understand the operating instructions.
- Be familiar with the safe operation of the blasting machine.
- Be physically and mentally fit to use the blasting machine.

WARNING

The consumption of drugs or alcohol impairing reaction time renders an individual unsuitable for operating the blasting machine! Individuals under the influence of the aforementioned substances are strictly prohibited from interacting with the blasting machine!

2.2 General safety guidelines

Danger

- Intentional Misuse of Dry Ice May Be Harmful or Fatal.
- Dry ice is a skin and eye irritant. Avoid contact with skin, mouth, eyes, and clothing. May cause severe frostbite or burns.
- Dry ice is harmful if eaten or swallowed. If eaten, seek medical help immediately.
- Dry ice changes to CO₂ gas as it sublimates (melts). Do not use or store in a confined space.
- Do not place dry ice in airtight containers. Airtight containers may explode as dry ice converts to CO₂ gas.

CO₂ concentration

Risk of suffocation on account of carbon dioxide. Dry ice pellets are CO₂ in a solid form. At normal atmospheric pressure, CO₂ can only exist in a solid form at a temperature of -79°C/-110°F or lower. When CO₂ is used as a blasting medium, it becomes heated and changes into a gaseous form. As CO₂ has a higher specific gravity than ordinary atmospheric air, inhaled air will contain CO₂ – especially if the blasting process takes place in small or partly closed rooms. In such conditions there is a risk of the oxygen content of inhaled air being replaced by CO₂. Therefore, it is essential to make sure the room is well ventilated when dry ice blasting!

- low CO₂ concentrations (3-5%) result in headaches and rapid breathing,
- CO₂ concentrations of (7-10%) produce headaches and nausea, and may lead to unconsciousness,
- higher CO₂ concentrations lead to unconsciousness and in the worst case – suffocation.

As stated above, high CO₂ concentrations can displace oxygen and result in unconsciousness. Therefore, avoid using the dry ice blasting machine in spaces/rooms where ventilation is limited.

CO₂ detector

The presence of a CO₂ detector is recommended in areas of limited ventilation such as rooms, closed tanks, etc. The CO₂ detector must be installed to interrupt the blasting process before the CO₂ concentration exceeds a prescribed limit.

Improper Usage

The manufacturer disclaims any liability for risks arising from improper use of the blasting machine. Such risks are solely the responsibility of the operator or operating personnel.

CAUTION

The use of this device for purposes other than those outlined in the manual is strictly forbidden.

- The blasting machine must not be used in environments with an increased risk of fire or explosion, corrosive environments, or environments with a heightened presence of dust.
- The specified performance parameters of the device must be adhered to at all times.
- The device must not be used if the intake hoses or blasting hoses are damaged.
- The blasting machine must not be used if there is a possibility of unintended movement.

2.3 Symbols on the machine

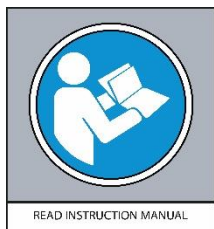

READ INSTRUCTION MANUAL



DANGER OF INJURY THROUGH CO₂



USE EYE AND EAR PROTECTION

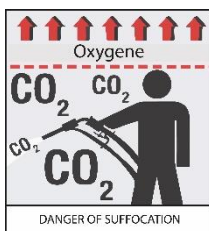

DANGER OF SUFFOCATION



WEAR GLOVES

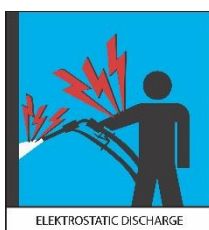

ELECTROSTATIC DISCHARGE



WEAR LONG SLEEVED INDUSTRIAL CLOTHES



DANGER OF INJURY ICE TEMPERATURE -79°C

Note

In the event of an emergency requiring immediate cessation of blasting, activate the

EMERGENCY stop button.



2.4 Static Electricity

Dry ice can cause electrostatic discharges. However, the equipment is bonded to the ground to minimize electrostatic discharge, and the warning sign is meant to instruct the operator to avoid placing the equipment in rooms containing explosive gasses. It is recommended to use a plastic shovel in the dry ice container.



Serious discharge of static electricity can occur. Always make sure that objects to be cleaned are adequately earthed/grounded and that this earthing/grounding remains stable throughout the whole cleaning process. The dry ice blasting machine is earthed/grounded, from machine cabinet to blasting gun, and through the main electricity connection on the rear side of the machine – provided that the machine has been set up and connected as described under STARTING MACHINE.

The user should always wear safety footwear class S2 or higher in order to protect himself from the static charge.

Dangers can arise from the machine if it is used improperly by untrained personnel. All users must be aware of these safety points. Improper handling of the machine and / or dry ice can threaten health and life, or at least cause serious damage.

Persons having a pacemaker are **not allowed** to work with the dry ice blasting machine.



2.5 Explosive Hazard

Attention!

The machine must never be used in surroundings where there is a **danger of explosion**. Despite optimum earthing/grounding of both machine and cleaning object, static electricity can be generated and create a spark.



3 Process description

The dry ice blasting equipment IC-430 operates with granules of dry ice pellets ($\varnothing 3$ mm), produced through the pressing of the CO₂ snow. The pellets are blasted on the surface to be cleaned. The dirt from the surface is frozen through thermal shock and it breaks because of the different expansion coefficients. The CO₂ granulate sublimates in the moment of impact from solid to gaseous state. Only the initial dirt remains behind.

The dry ice pellets in the hopper ($\varnothing 3$ mm) will be mixed using a compressed air operated dosing system, transported through the hose and accelerated through the blasting nozzle, the pellets can reach the speed of sound (depending on pressure and blasting nozzle).

BEFORE CLEANING

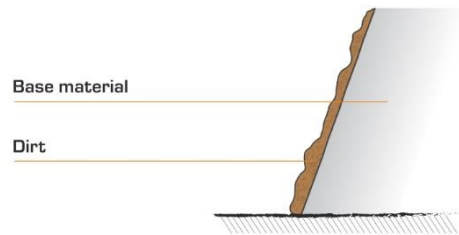

DURING THE CLEANING PROCESS

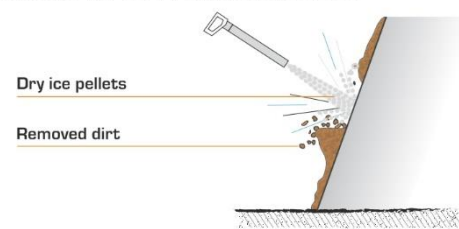

AFTER CLEANING

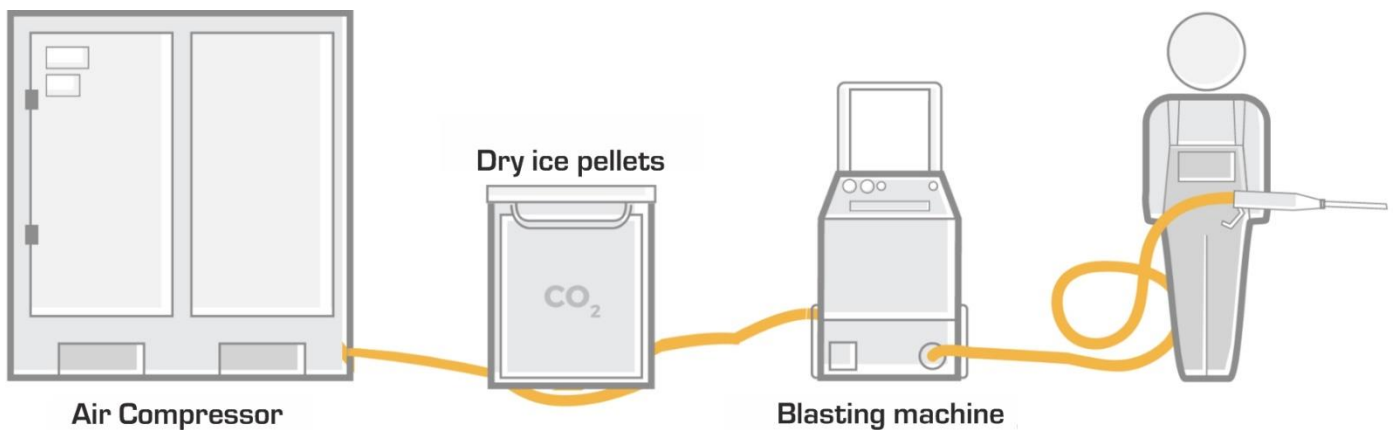
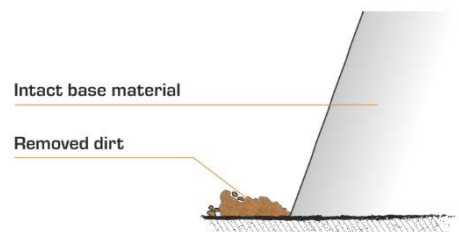

4 Machine technical data

Technical data

Electrical connection		
Supply voltage	V	110- 230 VAC /N/PE
Nominal apparent power	W	300
Frequency	Hz	50
Cos ϕ		0,96
Short-Circuit Current Rating (SSCR)	kA	10
Leakage current, typ.	mA	7,5
Residual current device (RCD)	mA	30
Dimensions IC-430		
Width	mm/inch	540/21
Depth	mm/inch	854/34
Height	mm/inch	980/38
Weight	kg/lb	124/265
Contents of dry ice container	kg/lb	25/55
Sound pressure level (EN 60704-1)	dB(A)	90 to 120
Compressed air		
Pressure supply min. - max.	bar/Psi	1-16 / 15- 230
Compressed air consumption	Nm ³ /min:	Up to 15 m ³ /h depend on nozzle

5 Setup and function

5.1 Unpacking the machine

The standard machine package will include:

- 7 m blast hose
- Personal protective equipment
- Blast gun IG-10-E
- Grounding kit 5m
- Round nozzle RN-10-10
- Flex case II. PLUS
- LED light for gun IG-10-02
- 10 m compressed air hose 3/4"
- Ice shovel (2kg/4,4lb capacity)

This machine has been assembled and tested as one unit prior to shipment. Follow the steps below to inspect and unpack the machine from the shipping container.

1. Examine the shipping container for any damages that may have occurred during transport.
2. Remove the machine. Recycle boxes and packaging.
3. Examine the machine for any external damage that may have occurred during transport.

Refer to the packing slip for a list of the components shipped with the machine. Contact ICS ice cleaning systems s.r.o. if any damage has occurred to the shipping container or the machine.

Only trained and/or certified personnel should operate or rig the machine for shipment or move.

5.2 Transport and storage

The following instructions are for proper transport of the machine. Follow all instructions as illustrated to avoid damaging the machine. It is recommended that only trained and qualified personnel use and move the machine.

- The handling handles on the machine for manual handling are marked in blue.



- Lifting the machine is allowed only according to the displayed image. A pair of transport bolts is used for lifting. Strapping the machine for long periods of time is not advised.

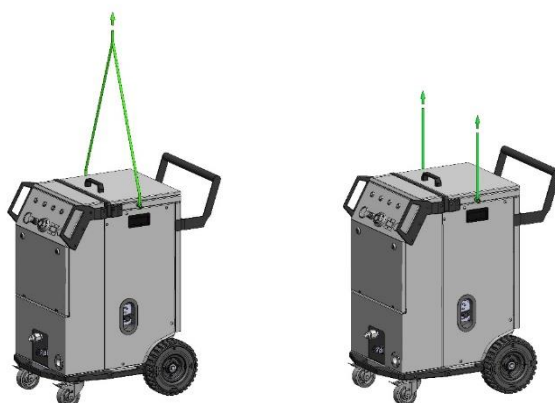

- It is forbidden to lift the device other than as shown in the picture.

Do not lift the machine using the front handlebar, upper handlebar, or the lower bumper as there will be no stability which could cause damage to equipment or harm to personnel.

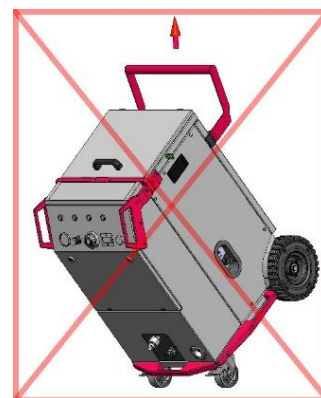

5.3 Machine illustrations and labels

Front view



No	Name
1	Manipulation holders for accessories
2	Control panel
3	Electrical cabinet
4	Front lockable wheels

Back view



No	Name
5	Back manipulation handle
6	Front manipulation handle
7	Ground conductor, loose
8	Back foot manipulation handle

Side view



No	Name
9	Tiltable hooks for accessories
10	Back manipulation holder
11	Removable side cover
12	Side holder

Front and back connection plate

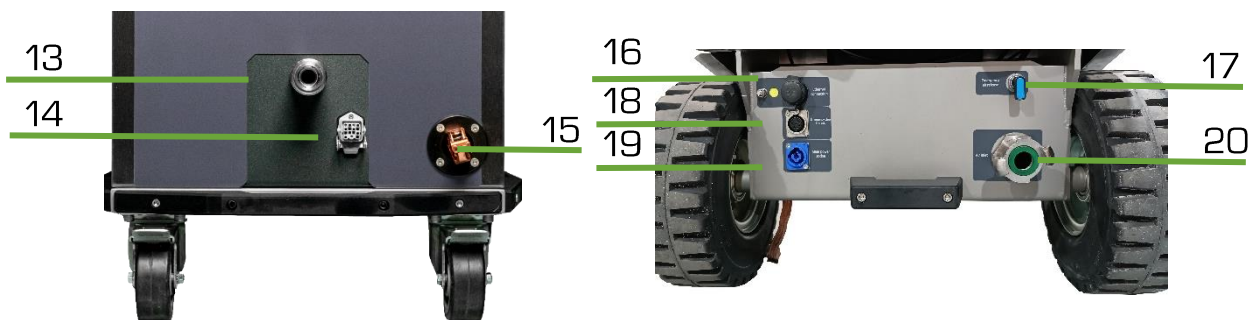

No	Name
13	Blast hose connection point
14	Applicator Cord connection
15	Static Ground Reel
16	Ethernet connection
17	Emergency pressure air release valve
18	Emergency interlock connector
19	Power supply connector
20	Inlet air connection

Connection hoses

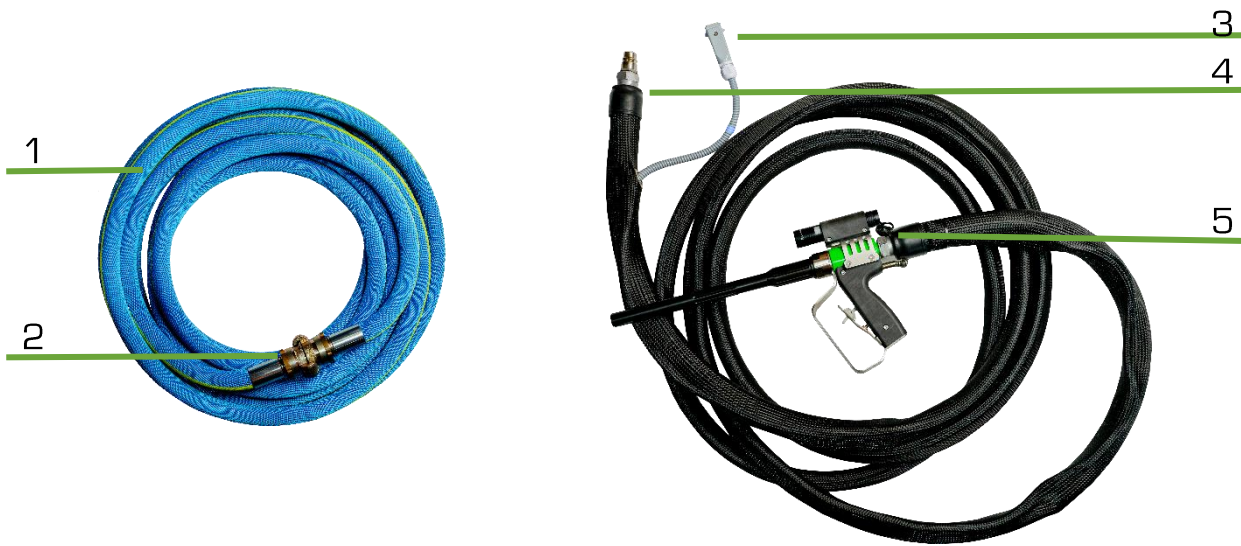

No	Name
1	Inlet air hose
2	Claw coupling
3	Signal cable to dry ice blasting machine
4	Hose coupling to dry ice blasting machine
5	Dry ice blasting gun

Dry ice blasting gun



No	Name
6	LED light
7	Signal cables coupling
8	Ergonomic handle
9	Two step trigger
10	Hand safety cover

5.4 Control panel

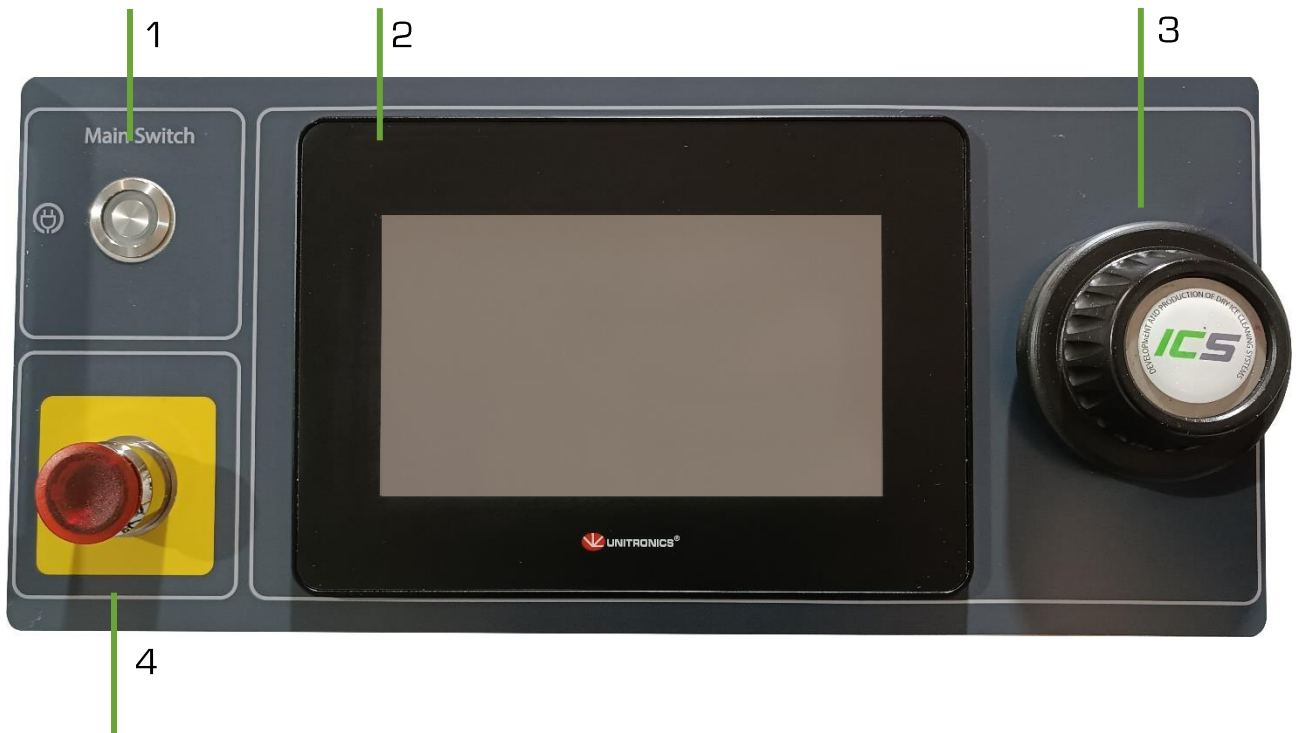

No	Name
1	Main switch
2	7inch HMI touch panel
3	Encoder button
4	Emergency stop

5.5 Device Grounding Procedure

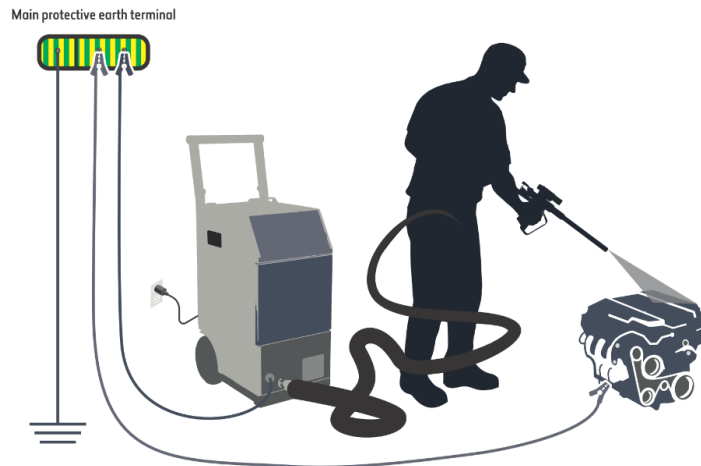

1. Connect the device to the building's grounding terminal.
2. Use the supplied grounding kit to connect the object being blasted to the primary grounding terminal.

The grounding kit on the device is marked as follows:

Yellow mark: 2m from the end of the rope. / Red mark: 1m from the end of the rope.
Extending the rope beyond the red mark may result in damage to the grounding kit!!!

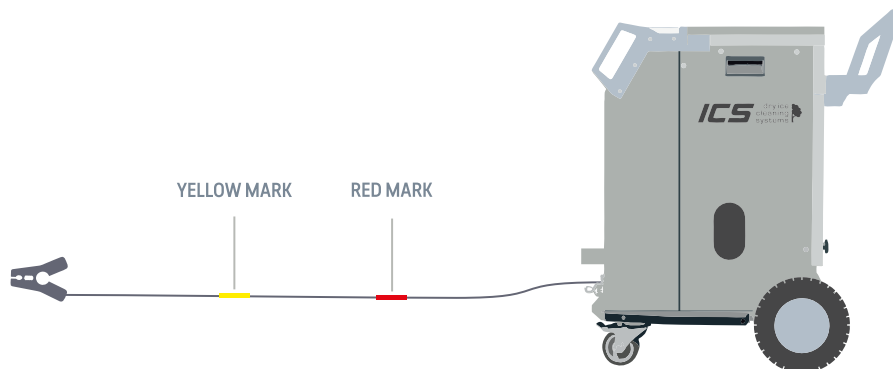

5.6 Starting machine

1. Make sure the machine is on a level, horizontal surface, and that the wheel brakes are applied.
2. Connect the compressed air hose using **the claw coupling by rotating the hose coupling in a clockwise direction until it snaps into place two times.**
3. Insert the plug of the power cord and turn it to the right until it locks by itself. Insert the grounded plug in a suitable socket.
4. Connect the signal cable at both ends of the blasting hose with the sockets on the front of the machine and the blasting gun.

CORRECT ORDER IS IMPORTANT!

FIRST connect the blasting hose couplings, then the signal cable.

5. Open the external compressed air supply (slowly).

- Machine is equipped with a Static ground Cable which is mounted on the front of the machine. Connect the Static Ground Cable to the item being blast cleaned or to an electrically conductive supporting structure of the material.

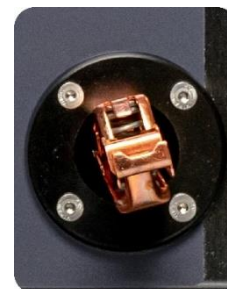

- Control panel procedure:

Push " Main Switch" button.



Release the E-stop button and then press the "Reset" button or click through the control wheel.

Set the necessary parameters on the machine. More information chapter 5.9

8. Lift the lock pin and activate the trigger on the blasting gun for a few seconds to allow air to flow through the system. This checks for moisture in the airstream and proper operation of the dosing disc, vibrator, and regulator.

Please note:

Before activating the blasting gun switch, the operator must be in a safe and stable working position. Depending on the jet pressure, the recoil on the jet gun also changes. At the highest jet pressure with the largest nozzle diameter, the recoil force can amount to 10 kg / 22 lbs, which is why it is ensured that the operator does not lose balance.

9. Place dry ice into the hopper and start the dry ice cleaning process.



5.7 Shutting down the machine

1. Empty the dry ice from the hopper.
2. Close the compressed air source.
3. Actuate the gun to release the residual compressed air.
4. Actuate the Off button.
5. Turn off the main switch.
6. Disconnect the power supply cable.
7. Detach the power plug and the air hose from the equipment.
8. Disconnect the hose package and roll it up.

5.8 HMI panel

5.8.1 Main screen

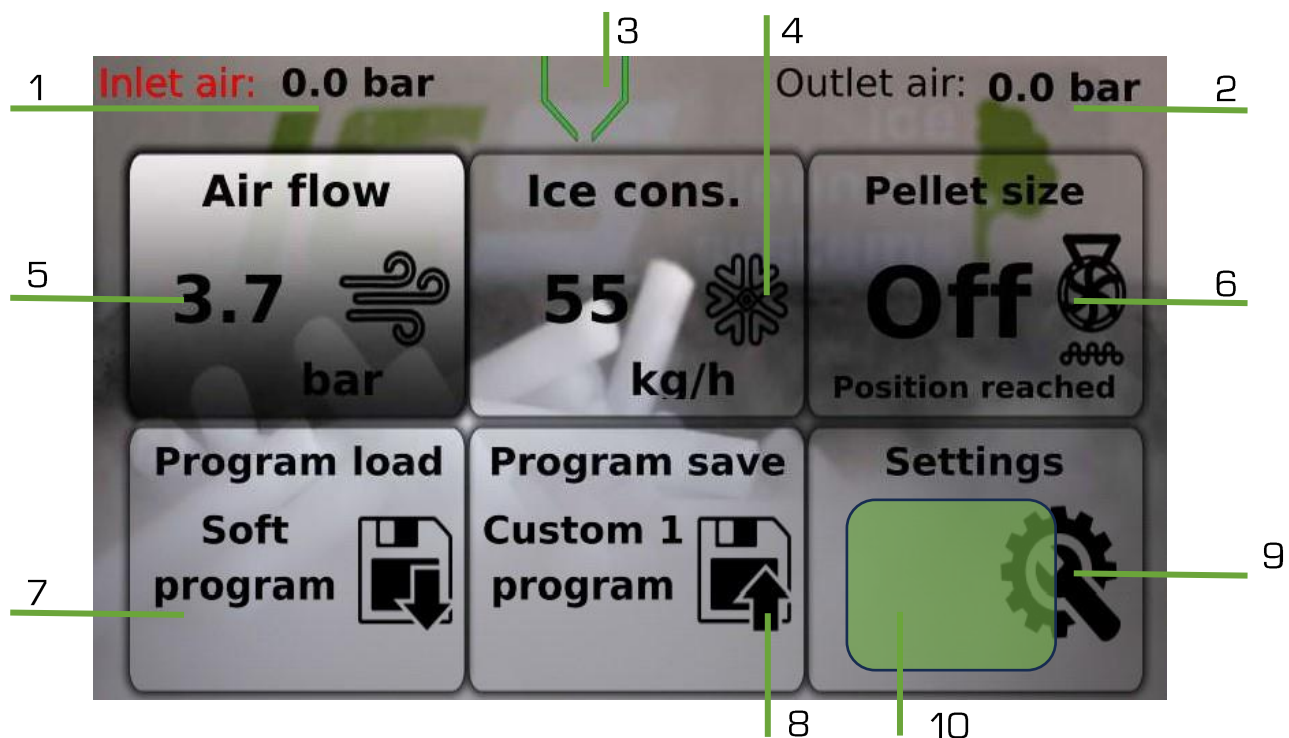

1. **Input Pressure:** If it flashes red, it means that the set pressure for blasting exceeds the input pressure of the device. If the inlet pressure drops below 1 bar, the unit will automatically switch to air blast mode to protect the systems.
2. **Output pressure indicator:** The pressure is 1 bar lower. When the gun is switched on, it will adjust to the desired blast pressure selected by the operator.
3. **Tray ice level indicator.**
4. **Dry ice consumption setting:**

The maximum dry-ice consumption depends on the pellet grinding size setting.

 - Air blowing
 - 10-100 kg/h = depending on the position of the grinder.
 - 100- 120 kg/h = when the grinder is fully open.
5. **Blast pressure adjustment:**
6. **Pellet grinding size.**
7. **Program load:** Possibility to load cleaning parameters: fine, medium, hard cleaning. The operator can save the current cleaning parameters under the program name custom1 and custom2.
8. **Program save:** After setting the parameters and selecting the desired saving of the custom1 or custom2 program, they are saved under the selected.
9. **Settings:** For the machine settings screen see chapter 5.9.2.
10. **Hidden touch button:** When touched for 3 seconds the HMI touch screen is loaded.

5.8.2 Settings screen

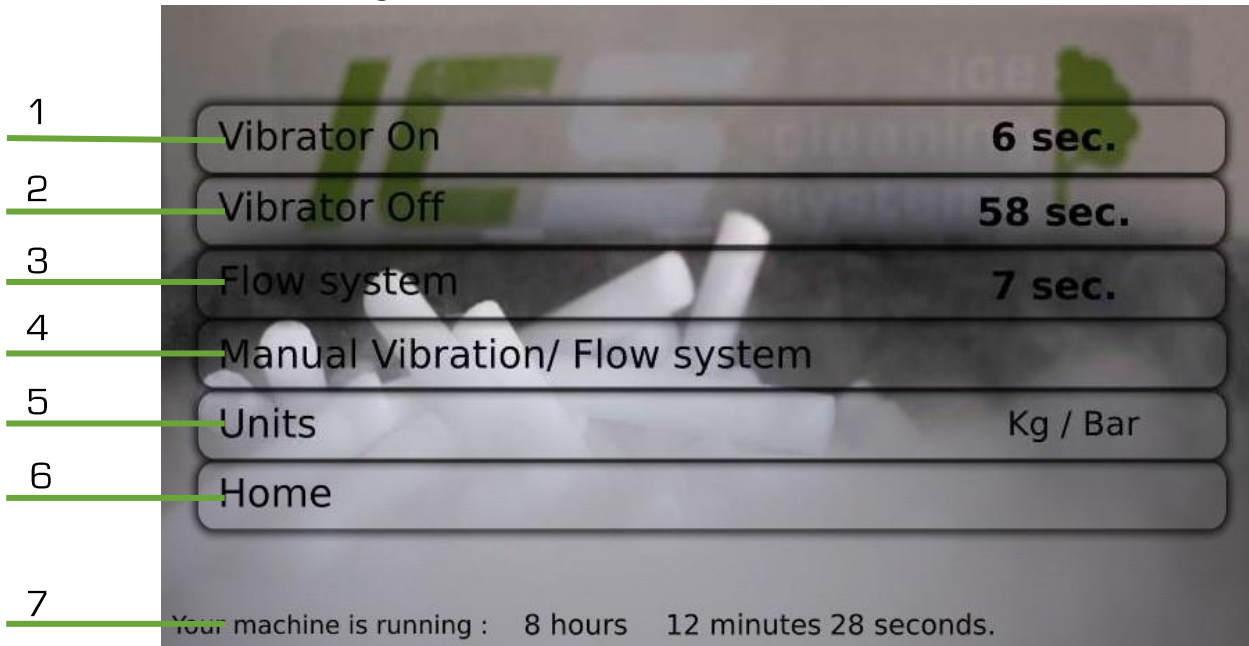

1. **Vibrator On:** Adjustment vibrator ON time
2. **Vibrator Off:** Adjustment the vibrator OFF time
3. **Flow System:** Set the frequency of the flow system.
4. **Manual Vibration / Flow system:** manually turn on the vibration + flow system.
5. **Units:** Switch between KG / BAR or LB / PSI
6. **Home:** Back to main screen
7. Hour counter

5.8.3 HMI touch screen

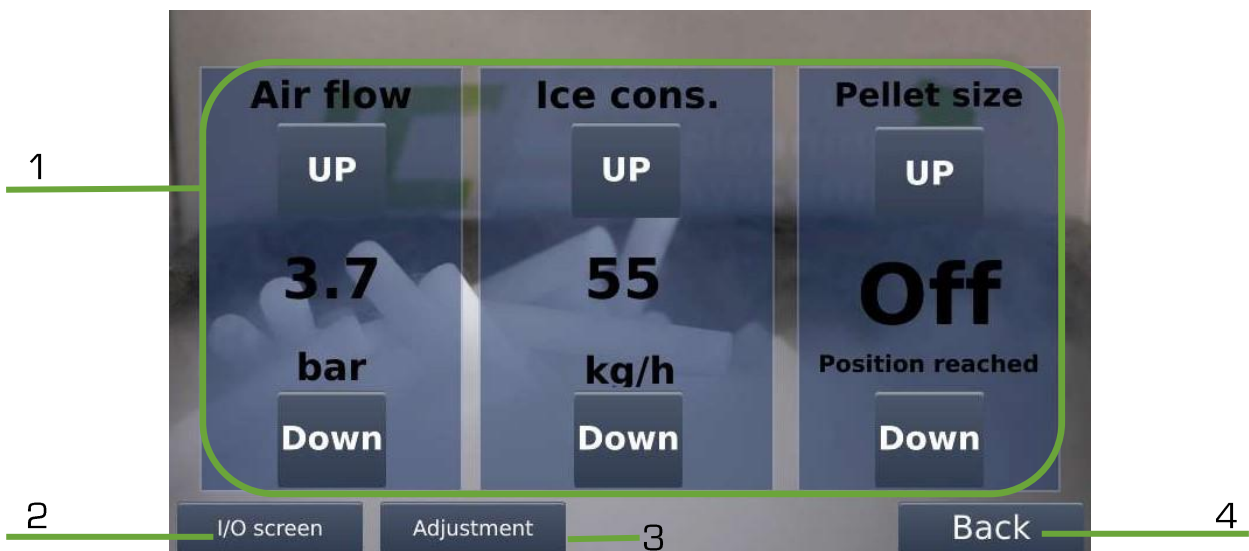

1. Touch blasting adjustment parameters.
2. Input /Output screen.
3. Adjustment.
4. Back to main screen.

Only an ICS service technician can adjust the parameters in the adjustment screens.

5.8.4 Adjustment screens

Delay ON/OFF adjustment		ON	OFF
-4KH1- Press reg		300 ms	800 ms
-2M1- Main motor		10 ms	200 ms
-2M2 Vibrator		1000 ms	500 ms
-4Y1- Blast solenoid		1 ms	1000 ms
-4Y2- Flow system		500 ms	500 ms
-5M1- Feeding system		250 ms	1 ms
-5M2- Scrambler system		10 ms	200 ms

1. Adjustment table: Time delay for blast ON/ OFF.
 2. Gun On/Off counter: 853
 3. Fault bypass: SET
 4. Low Input pres. bypass: SET
 5. Blast button
 6. Back button

1. Adjustment table: Time delay for blast ON/ OFF.
2. Gun switch counter:
3. Fault bypass: disable all faults.
4. Low input pressure bypass: Disable low input pressure function.
5. Blasting button: Manual blasting button for testing.
6. Back: Back to main screen.

Input/Output screen.

Reading machine inputs/outputs used for machine diagnostics.

Digital inputs		Digital outputs	
DI0 - Gun micro switch		DQ0 - Vibrator	<input type="checkbox"/>
DI1 - Gun plus		DQ1 - 5M2 enable	<input type="checkbox"/>
DI2 - Gun minus		DQ2 - Estop relay	<input type="checkbox"/>
DI3 - Gun air adjust		DQ3 - Blast solenoid	<input type="checkbox"/>
DI4 - Gun cons. adjust		DQ4 - Flow solenoid	<input type="checkbox"/>
DI5 - Hose check		DQ5 - 2M1 enable	<input type="checkbox"/>
DI6 - Estop feedback		DQ6 - 6M1 IN1	<input type="checkbox"/>
DI7 - 6M1 OUT1		DQ7 - 6M1 IN2	<input type="checkbox"/>
DI8 - 6M1 OUT2		DQ8 - 6M1 IN3	<input type="checkbox"/>
DI9 - Motors OK sig		DQ9 - 6M1 IN4	<input type="checkbox"/>
DI10 - Encoder A		Analog signals	
DI11 - Encoder B		AQ0 - 4KH1 PressReg	0
DI12 - Encoder Click		AQ1 - 5M1 MotorSpeed	0
DI13 - 5M1 feedback		AI0 - InputPressure	3289
Tmp_Down 25.2	Tmp_Up 26.1	AI1 - RegulatorFdbck	1622

Back

6 Troubleshooting and maintenance

6.1 Preventive maintenance

Thanks to its practical structure, the IC-430 equipment only requires a very low maintenance.

For the IC-430, maintenance works should be performed on a regular basis at every 1,000 operating hours, and at least once a year. See the yearly control sticker.

We recommend concluding a maintenance contract with ICS Ice Cleaning Systems or with an ICS authorised partner.

6.1.1 Daily maintenance

1. Check the power supply cable and signal cable.
2. Pay special attention to places on the blasting hoses where kinks may have occurred during operation.

If any kind of damage to the blasting hose or the machine itself is noted, such damage must be repaired either by an ICS technician or by the owner's qualified personnel who has been trained by ICS in the repair and maintenance of dry ice blasting machines and accessories. Beyond the necessary knowledge, the person concerned must have appropriate tools and equipment, as well as the auxiliary materials required, at his disposal.

6.1.2 Safety Mechanisms Check

Perform a check of the safety mechanisms every three months to ensure their correct function and effectiveness.

EMERGENCY STOP Button Check

1. Press the red EMERGENCY STOP pushbutton to check its function; the button should remain in the pressed position and all movements of the device should immediately cease.
2. Rotate the EMERGENCY STOP pushbutton to the right to release it. The device should remain deactivated.

SAFETY SENSOR FOR SIEVE PRESENCE Check

1. Verify that the safety proximity sensor, which checks the presence of the hopper sieve, is functioning correctly. Upon removal of the sieve, all movements of the device should immediately cease.
2. After reinserting and securing the sieve with screws, the device should remain deactivated. The device should only reactivate upon resetting using the RESET button on the control panel.

If any deficiency, damage, or malfunction is detected during the aforementioned procedures, the operating personnel should immediately cease the checking procedure and deactivate the MASTER SWITCH.

Due to the components used to ensure safe access to potentially dangerous internal areas with high values of PFHD and MTTFD, the frequency of access does not affect the service life of the device's safety mechanisms. The minimum service life of the safety components is 20 years.

6.1.3 1000 hours maintenance

1. General visual inspection of body, weld joints, chassis, tires, screw seat .
2. If necessary, complete exterior and interior cleaning.
3. Checking the functioning of the inlet pressure regulator and pilot pressure regulator.
4. Cleaning control air filter; replacing filter.
5. Checking the pneumatic control elements, checking for leaks and replacing the shock absorber.
6. Complete electrical inspection, including contacts, voltage converter, frequency inverter, electric motor, firm seating of elements and terminals.
7. Checking the entire ice dosing system for signs of wear, if it is functional and leak-proof.
8. Checking the functioning and firm seating of the vibrator
9. Checking the ice loosening system, including the electro-pneumatic control, for signs of wear, if it is functional and safe for use.
10. Checking the hose package for signs of wear, if it is functional and leak-proof (pressing)
11. Checking the connecting elements, connectors and pneumatic couplings for signs of damage, if they are functional and safe for use.
12. Checking the blast gun if it is functional and safe for use.
13. Checking the existing blasting nozzles for signs of wear and cracks.
14. Pressure and safety test.
15. Functional test.
16. Blasting test.
17. Replacing the inspection and maintenance plates.

6.2 Faults

Problem	Description	Corrective action
The equipment cannot be started	The Reset button is lit despite actuation.	Unlock the Emergency Stop button by pulling it. Check the hopper grid for firm seating.
The equipment does not start	Nothing happens after the gun has been actuated.	Check whether the control line is blocked.
No air comes out from the gun	The equipment is running, but it does not blow out air.	Check the compressed air supply and the connection of the equipment and adjust the desired blast pressure at the equipment.
No ice comes out	After actuating the gun, only air and no ice comes out.	Place ice in the hopper. Set a minimum quantity of 10 kg/h.
The equipment is running, but no ice comes out	Ice is falling down on the lower part of the equipment	Blast pressure, amount of ice and the blasting tube are not optimally combined with one another and adjusted to each other.

7 Repair and Warranty

Please bear in mind that the works, including the inspection and maintenance works, especially at the safety devices, can be carried out only by an ICS technician or by a person who received special training for equipment and accessories of ICS Ice Cleaning Systems s.r.o. and who can present evidence in this respect.

The potential repairs necessary during the warranty period have to be agreed upon beforehand with ICS Ice Cleaning Systems.

The spare parts which fail in the warranty period are replaced either at our location or are sent to you. The transportation costs, travel costs and costs related to the stay, as well as those for the disassembly and reassembly fall on the client.

For the evaluation of the warranty, the component or the equipment shall be sent to ICS Ice Cleaning Systems.

Warranty conditions

The warranty becomes void in the following cases:

- incorrect handling of the IC-430 equipment.
- using non-original spare parts.
- works at the IC-430 equipment carried out by unauthorised persons.
- using materials different than dry ice.
- noncompliance with the requirements regarding compressed air quality.

Carrying out unauthorised changes to the IC-430 equipment is prohibited!



The warranty is subject to the GTC of ICS ice cleaning systems s.r.o.

8 Technical schematics

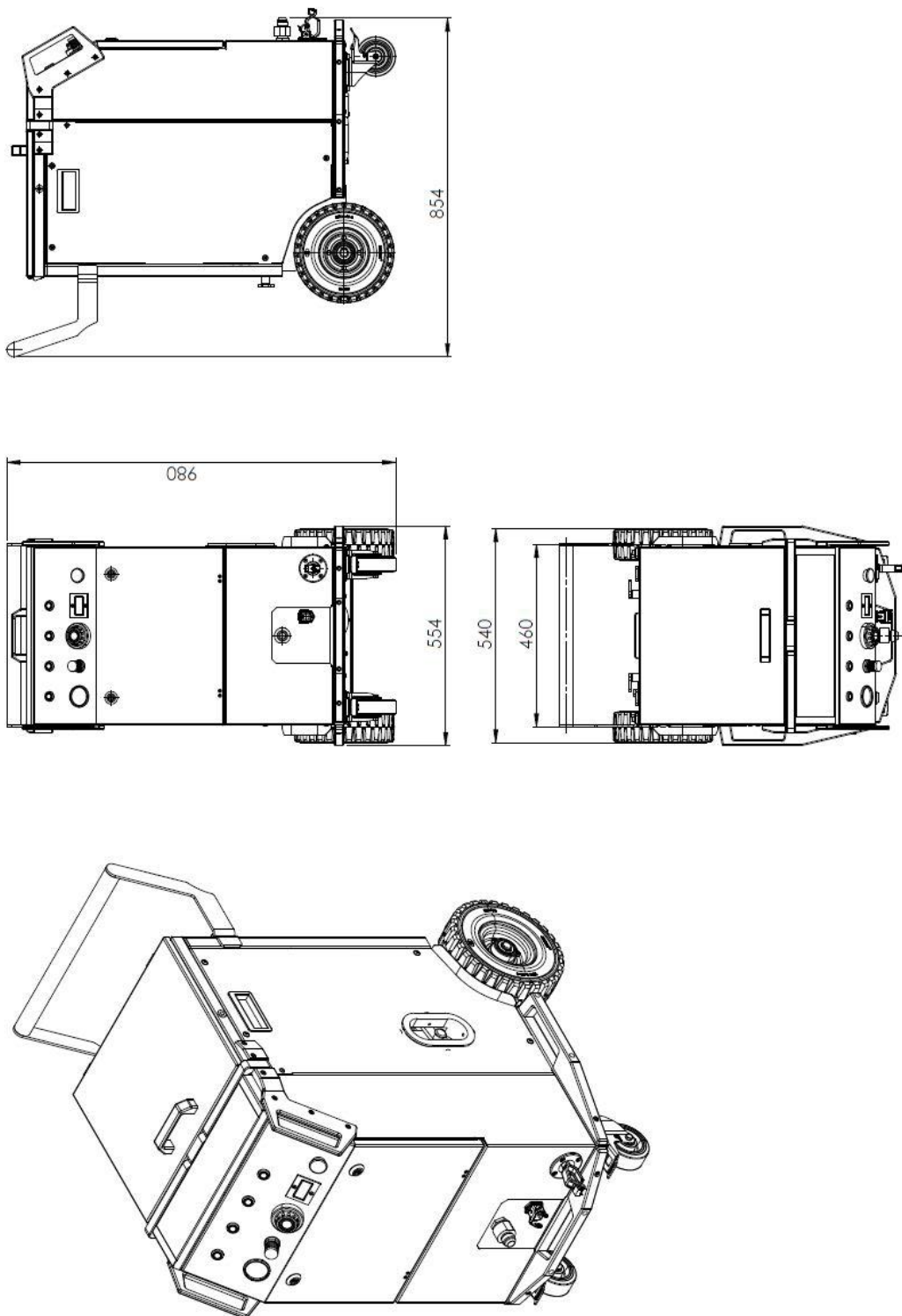
8.1 Dimensional drawing



8.2 Electrical schematics

0	1	2	3	4	5	6	7	8	9
ICSform_IC-430									
 <p>ICS Ice Cleaning Systems s.r.o. Robotnícka 2192, Povazska Bystrica 017 01 Tel. +421 (0)42 42 61 135</p>									
Popis projektu Číslo výkresu			Dry ice blasting machines IC-430-02						
- Main voltage : 110-230 VAC L1 = black N = light blue PE = yellow-green - Control voltage : 24VDC 24VDC = dark blue 0VDC = dark blue/white									
- Electrical schematic number : IC-430-02			Počet stran 15						
Vytvořeno dne Zpracováno dne			31. 3. 2022 8. 4. 2024						
Datum Zprac. Zkont. PŘV.			30. 1. 2024 WHTLO Název Názov						
Změna			Project name: IC-430 blasting machine Schematic version: IC-430-02 Název zobrazení: Názov zobrazenia						
			ICS Ice Cleaning Systems s.r.o.  dry ice cleaning systems The only way to do it.						
			Title page IC-B00-02 List Strana 1 / 15						

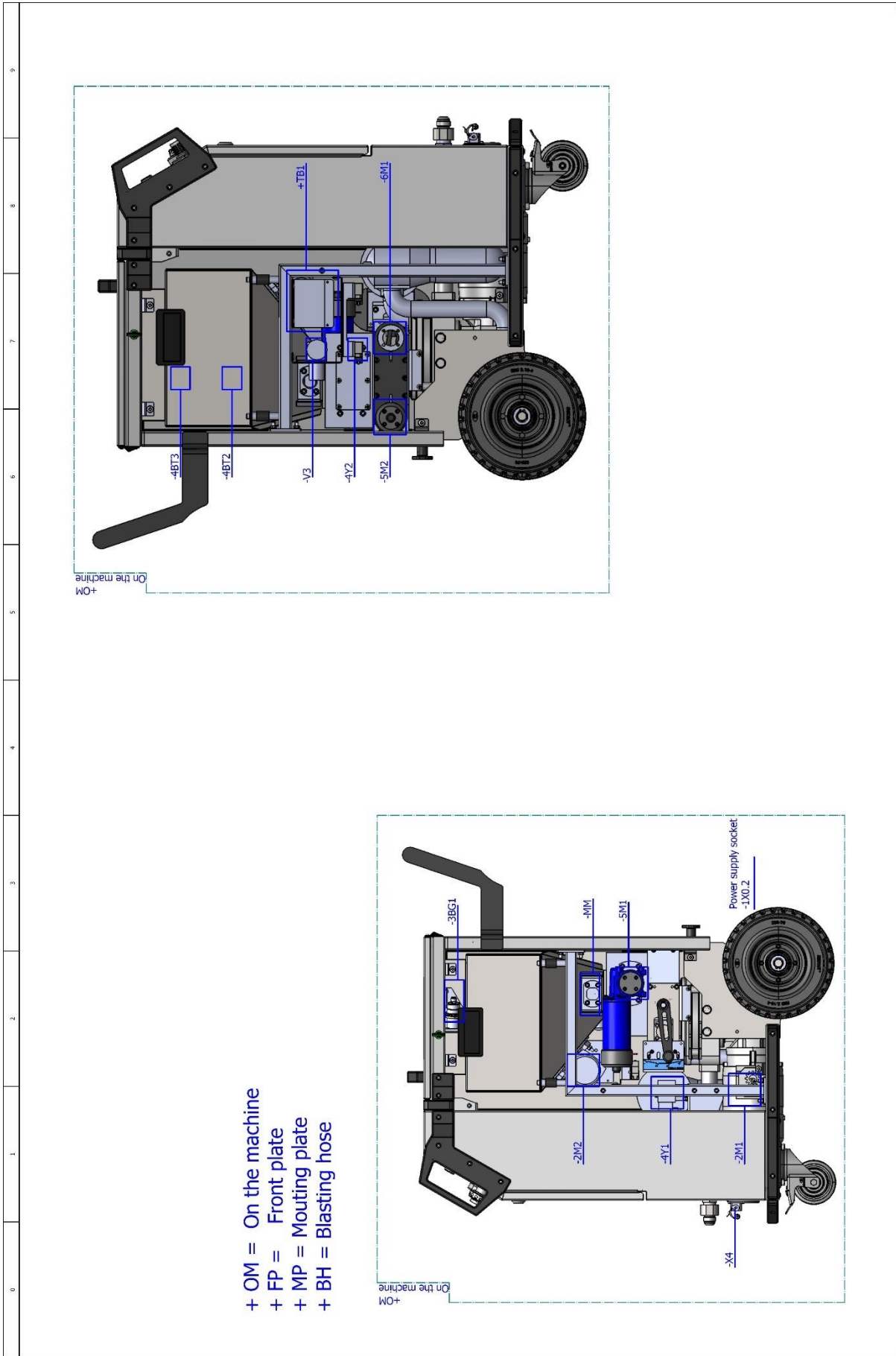

- + OM = On the machine
- + FP = Front plate
- + MP = Mounting plate
- + BH = Blasting hose

1		Datum: 8. 4. 2024		Project name: IC-430 blasting machine		ICS Ice Cleaning Systems s.r.o.		Machine_layout_1		3	
Změna		Zprac: ICS/28pac		Schematic version: IC-430-02		ICS		IC-430-02		List	
Misev		Přev:		Návrhář: Z		dry ice cleaning systems		Strana		2 / 15	
				Návrhář: Om		dry ice cleaning systems					

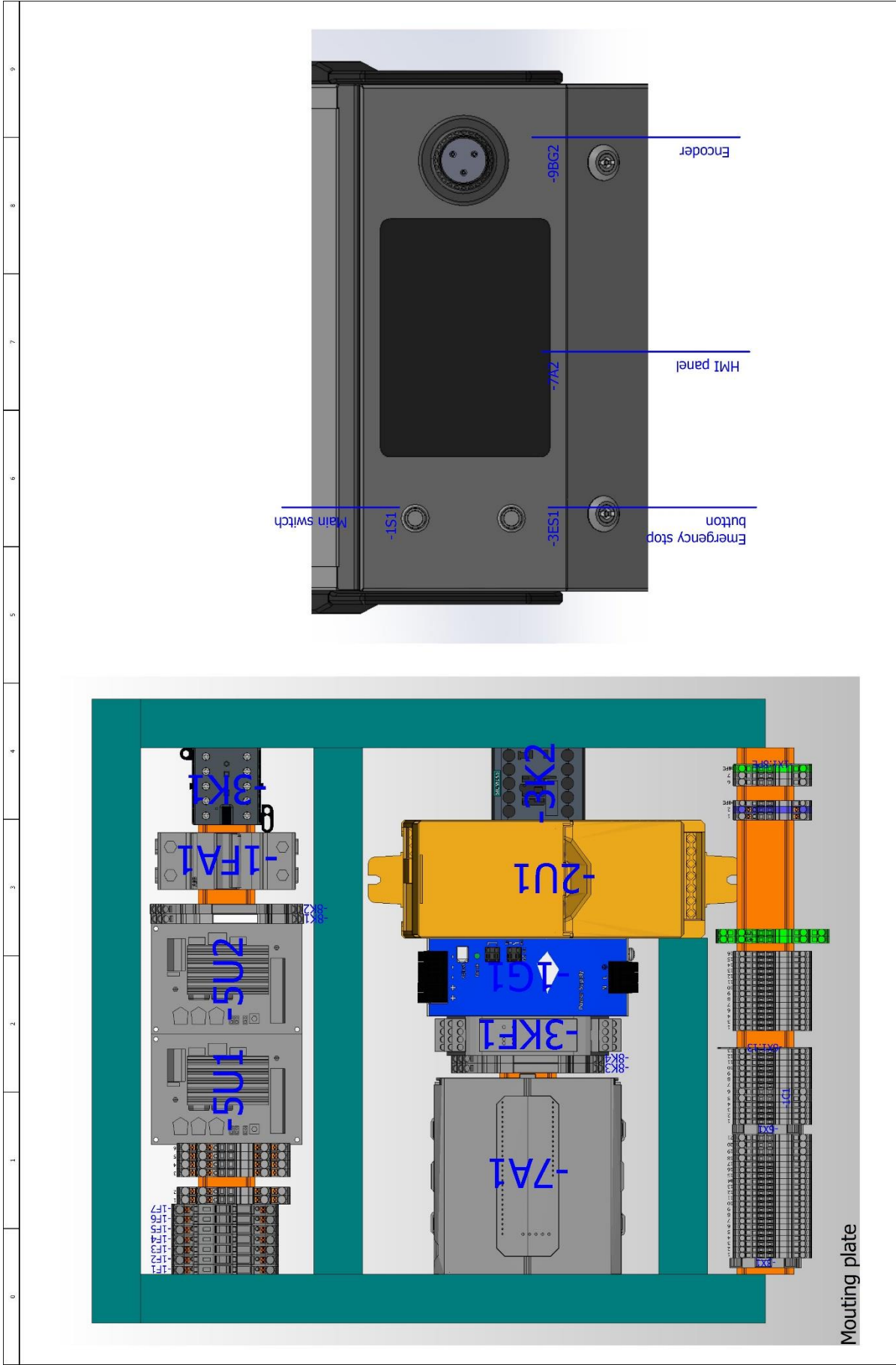

2		+MP/1	
Project name: IC-430 blasting machine		Machine_layout_2	
Schematic version: IC-430-02		IC-430-02	
Nitradař z		Lit	
Nitradař 0m		Strana 3 / 13	
Datum	21. 2. 2024		
Zprac.	WINUO		
Zařad.			
Přev.			
Měřev			
Změna			

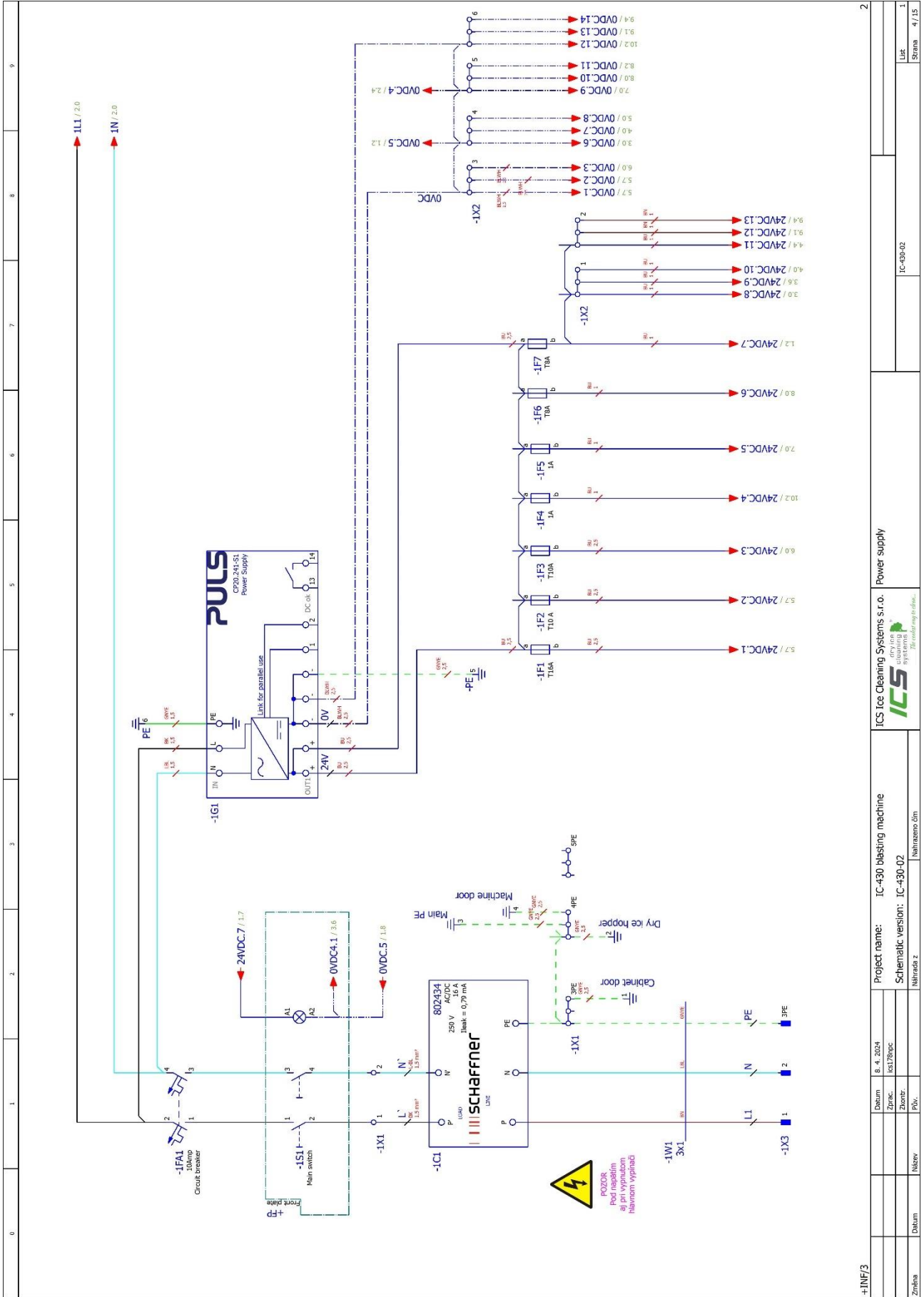

+INF/3

Project name: IC-430 blasting machine
Schematic version: IC-430-02

Datum	8. 4. 2024	Power supply	IC-430-02	Strana	4 / 15
Zprac.	icst/799c			List	
Začet.					
Přev.					
Název	Náhradná z				
Druh	Náhradný čm				

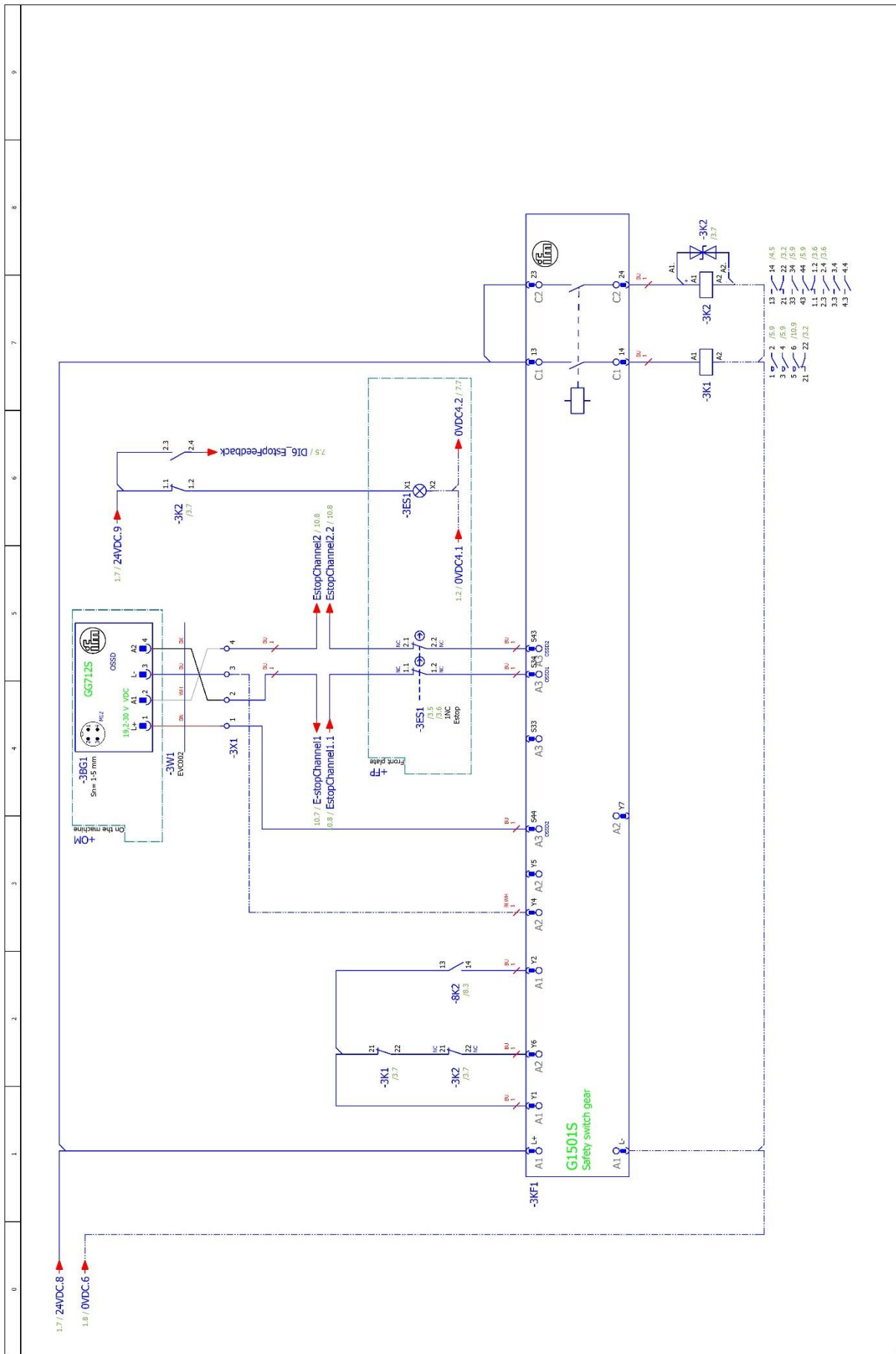

2	Project name: IC-430 blasting machine				Estop Connection			
	Schematic version: IC-430-02				IC-430-02			
Zofers	Datum	15. 5. 2024	Zurück	15.12.2023	Mitarbeiter	Öm	IC-430-02	3
	Zust.							6 / 15
	Rev.							

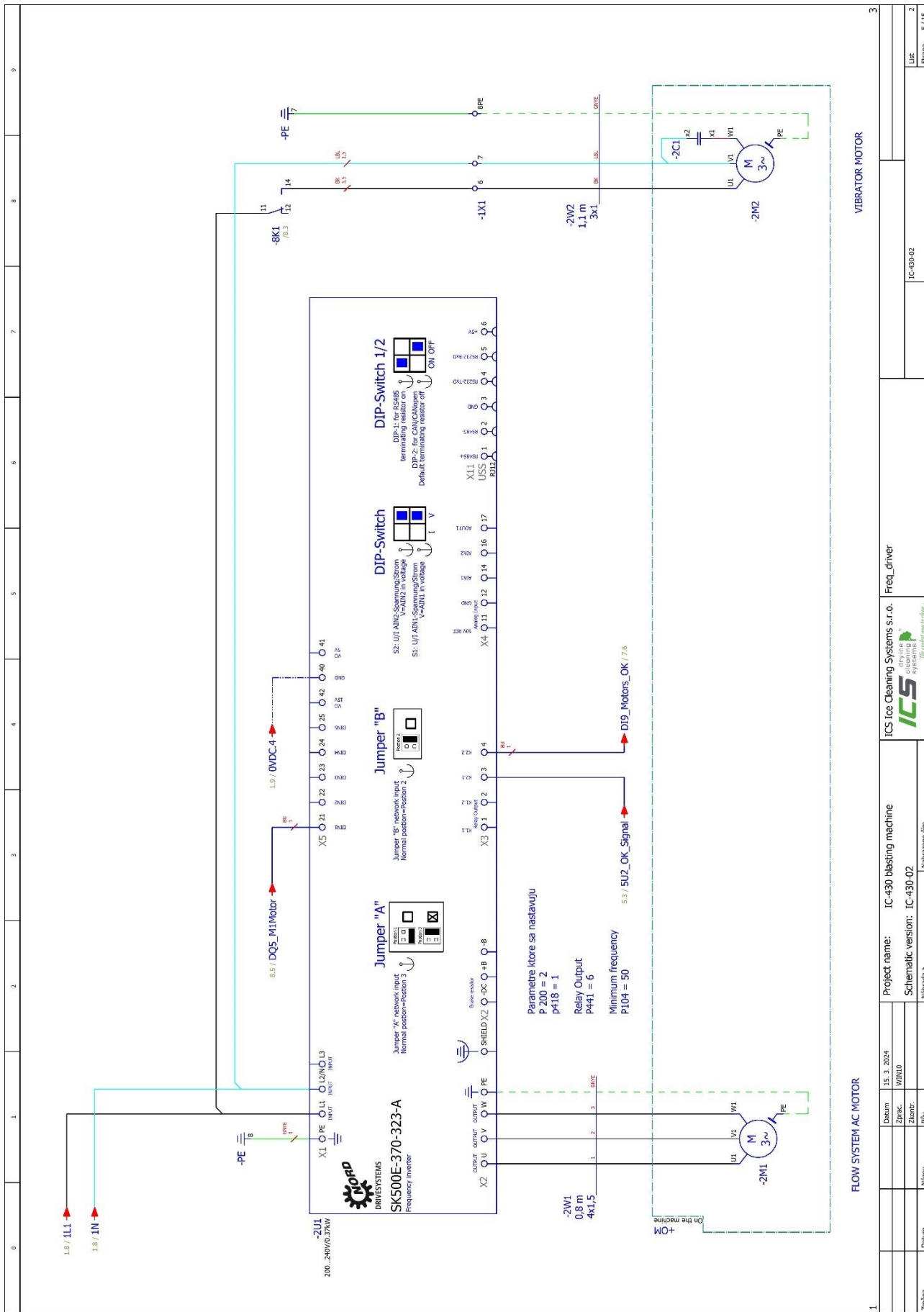

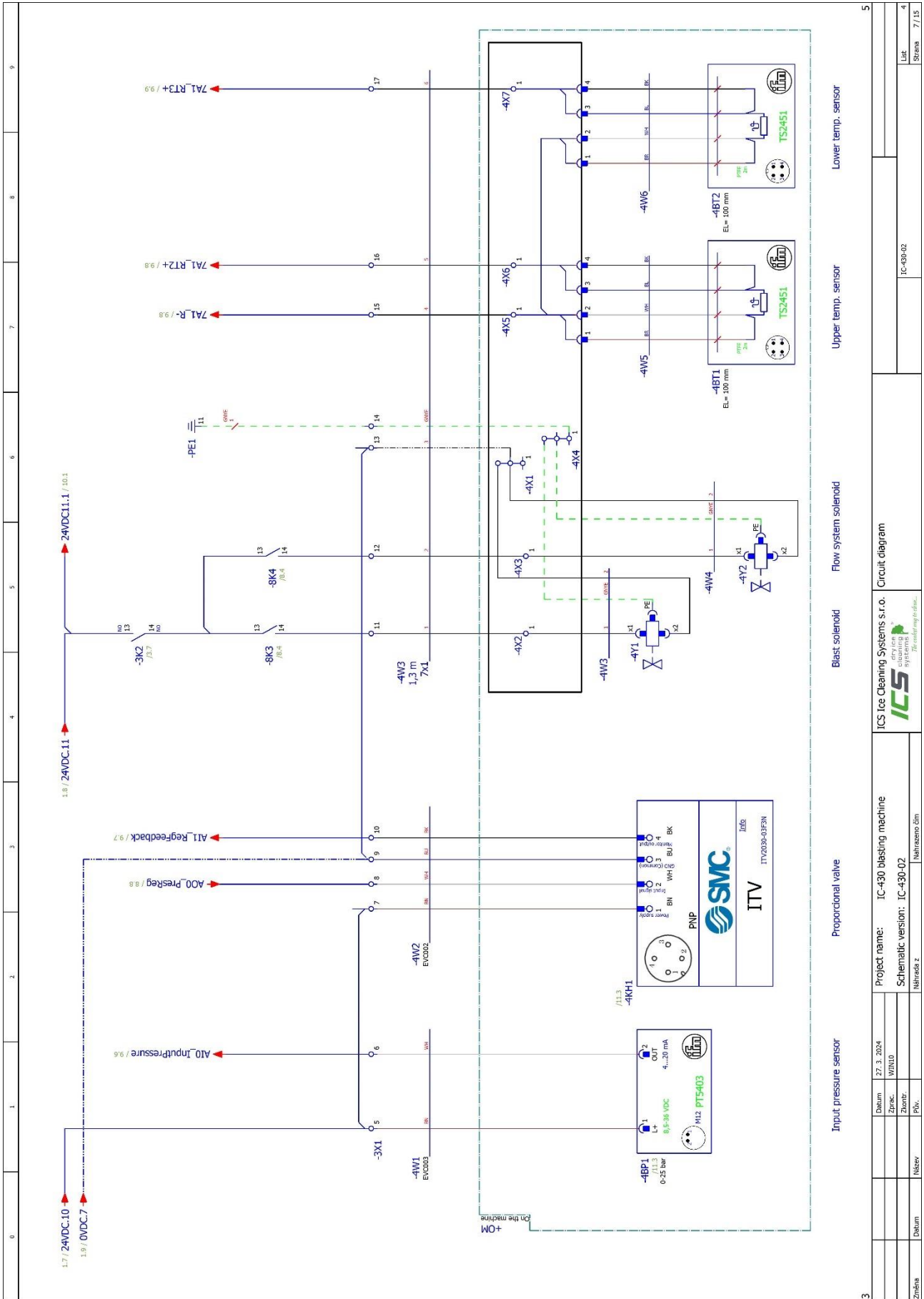

3

Project name: IC-430 blasting machine
Schematic version: IC-430-02

Datum	27.3.2024
Zurück	WIN10
Zusatz	
Rev.	

ICS Ice Cleaning Systems s.r.o.
dry ice cleaning systems
The Technology of the Future

Circuit diagram

IC-430-02

Seite 7 / 15

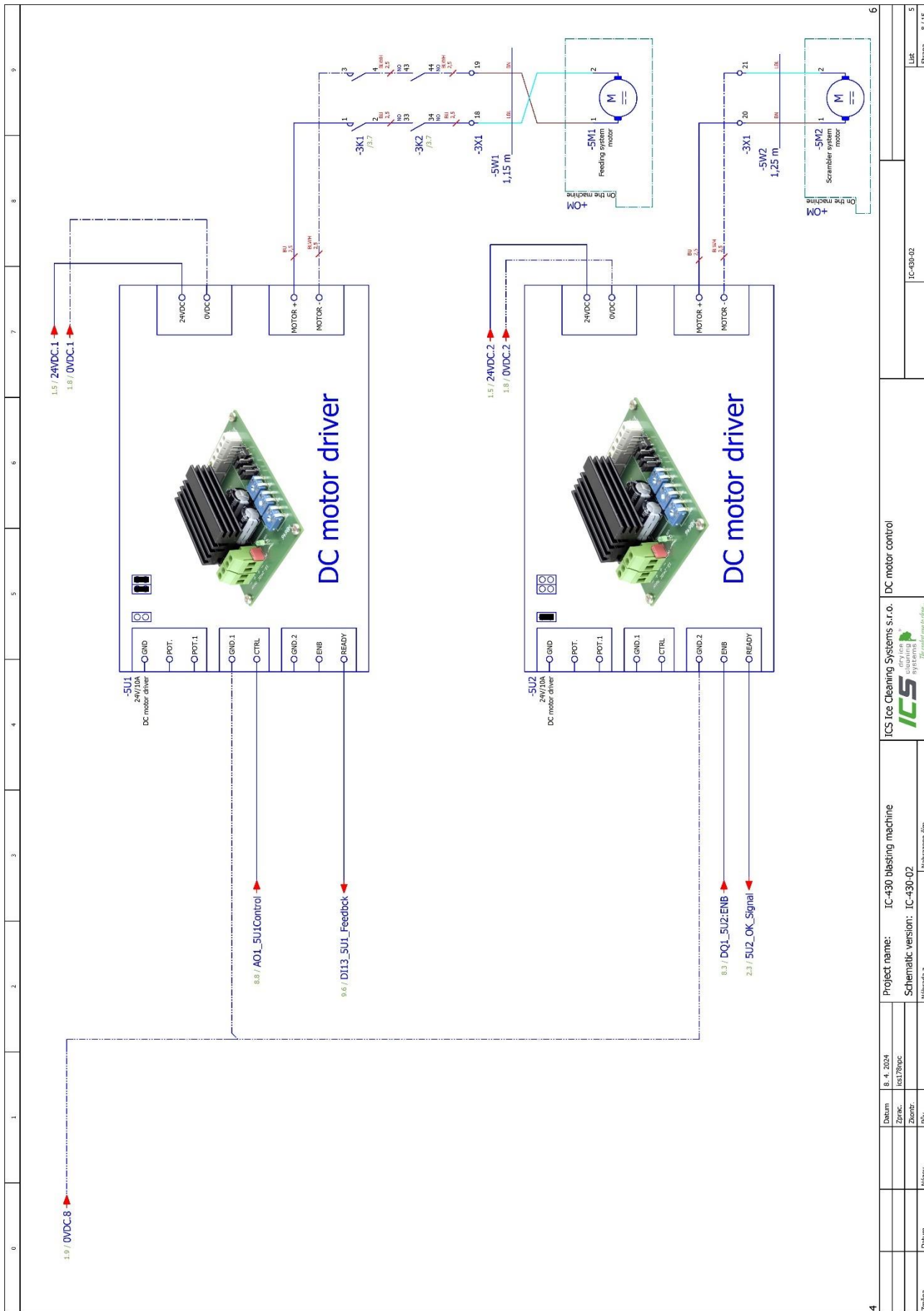

4

6

Date: 8.4.2024		Project name: IC-430 blasting machine		DC motor control	
Author: Ics17@ic		Schematic version: IC-430-02		IC-430-02	
Drawn: Mihail Z		Name: Mihail Z		List: Strana 8 / 15	
Checked: Mihail Z		Name: Mihail Z		List: Strana 8 / 15	

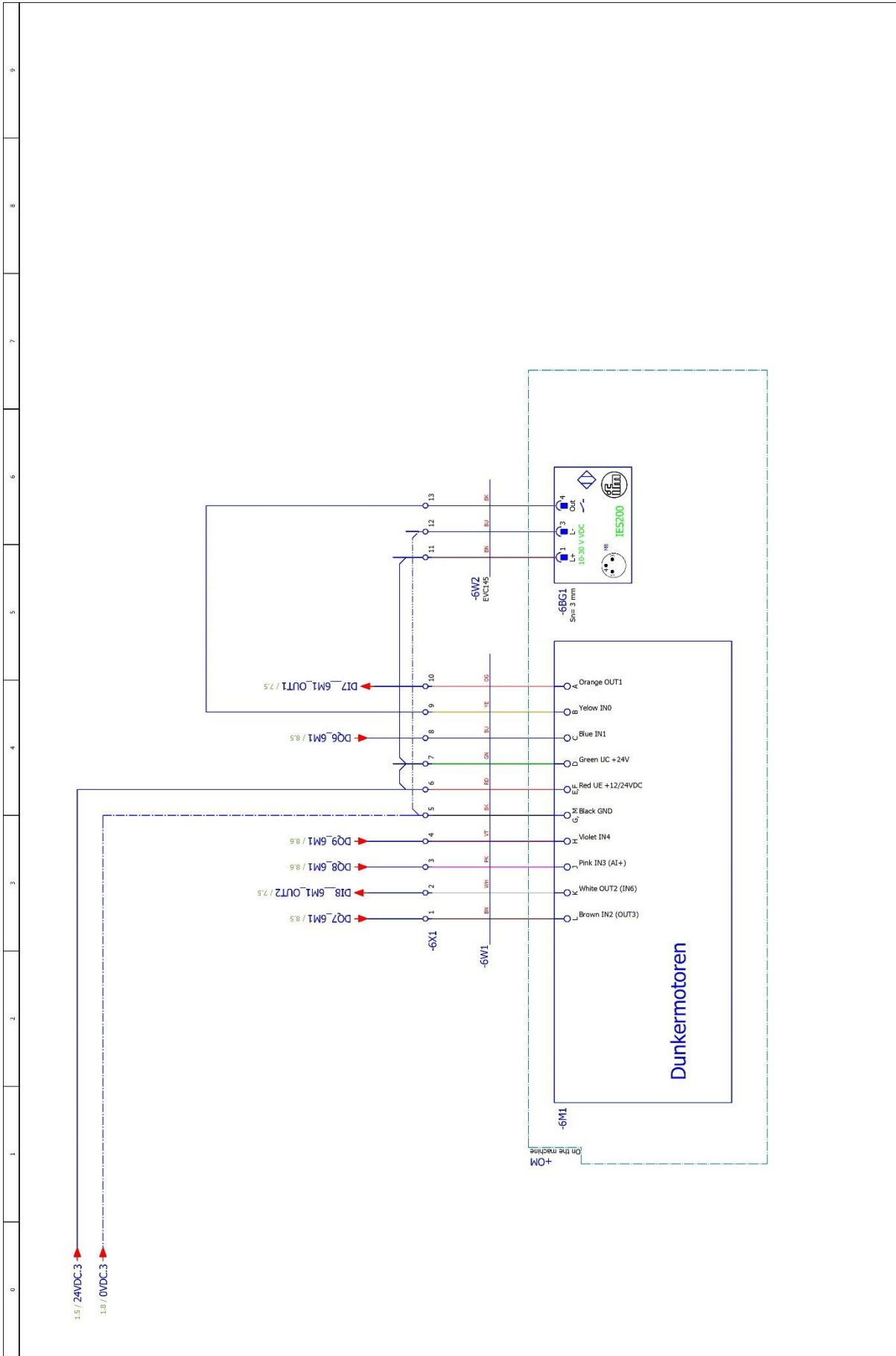

5		Project name: IC-430 blasting machine		IC-430-02		DC motor control 2		IC-430-02		List	
6		Schematic version: IC-430-02		Nitradsch 2		Nitradsch 0m		Strana		9 / 15	
Datum		8.4.2024		Zurück		Zusatz		Pkw.		Mitarbeiter	
Zuletzt		8.4.2024		Zurück		Zusatz		Pkw.		Mitarbeiter	

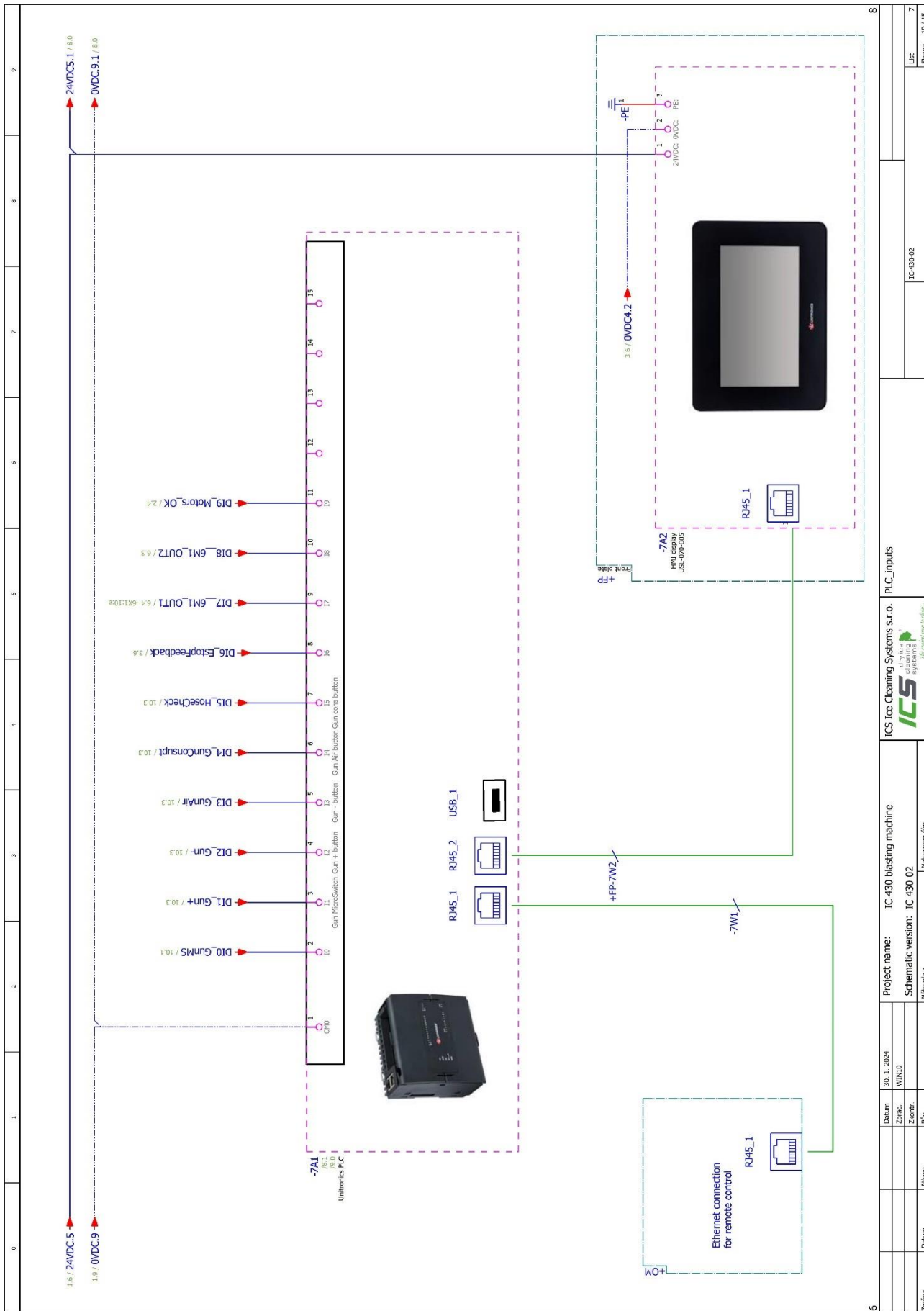

6		30.1.2024		IC-430 blasting machine		PLC inputs	
Datum:		30.1.2024		Project name:		IC-430-02	
Zurück:		WIN10		Schematic version:		IC-430-02	
Zuerst:				Nitradsch 2		Strana 10 / 15	
Pkw:				Nitradsch 2m			
Datum:				Nitradsch 2m			
Mitarbeiter:							
Zuletzt:							

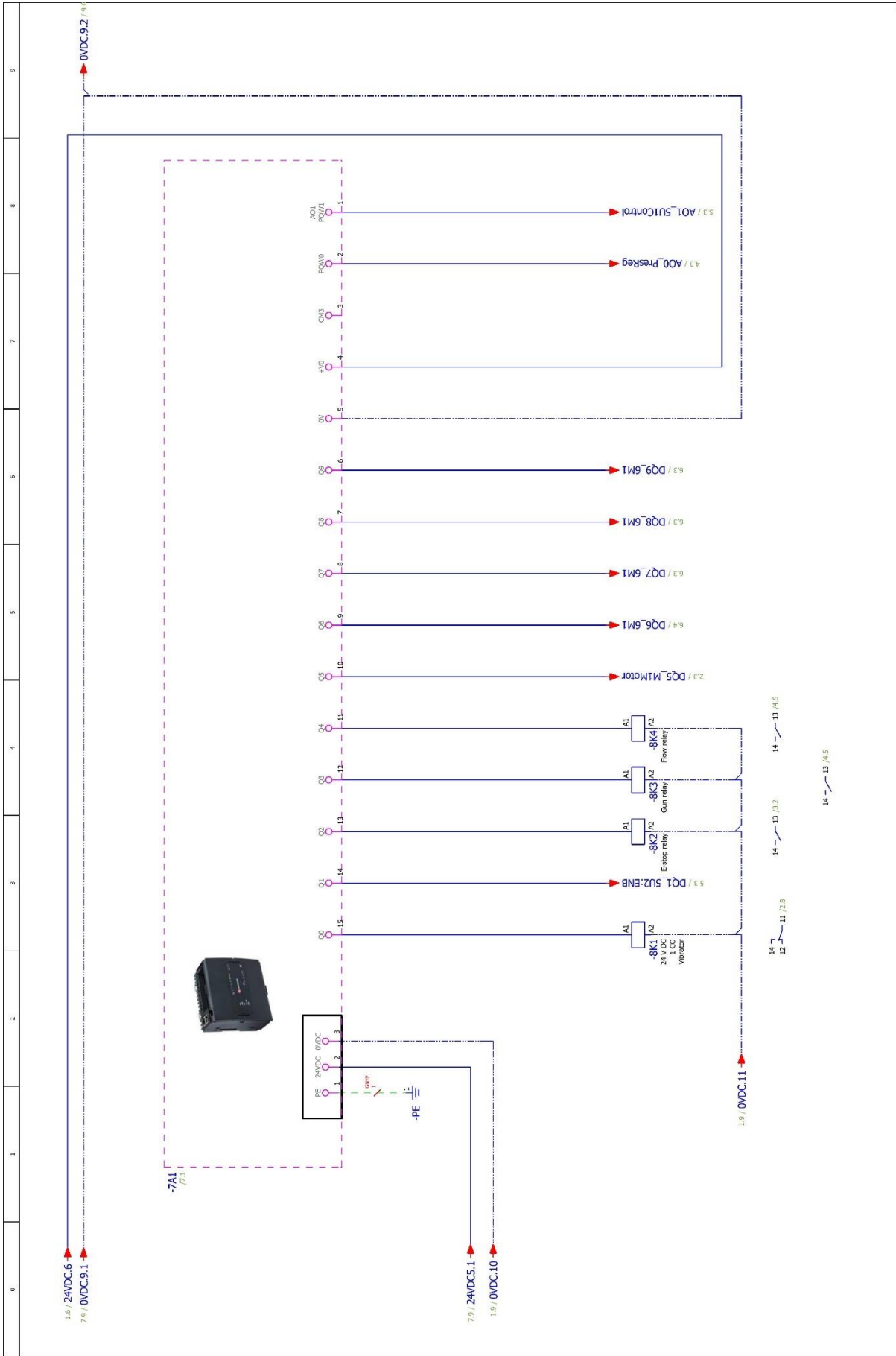

7		27.2.2024		IC-430 blasting machine		PLC Outputs		9	
Datum		27.2.2024		Project name: IC-430 blasting machine		ICS Ice Cleaning Systems s.r.o.		IC-430-02	
Zprac.		Ist/79pac		Schematic version: IC-430-02		ICS		Strana 11 / 15	
Přev.				Návrhář: Z		dry ice cleaning systems		List	
Měrov				Návrhář: Z		dry ice cleaning systems		Strana 11 / 15	
Změna				Návrhář: Z		dry ice cleaning systems			

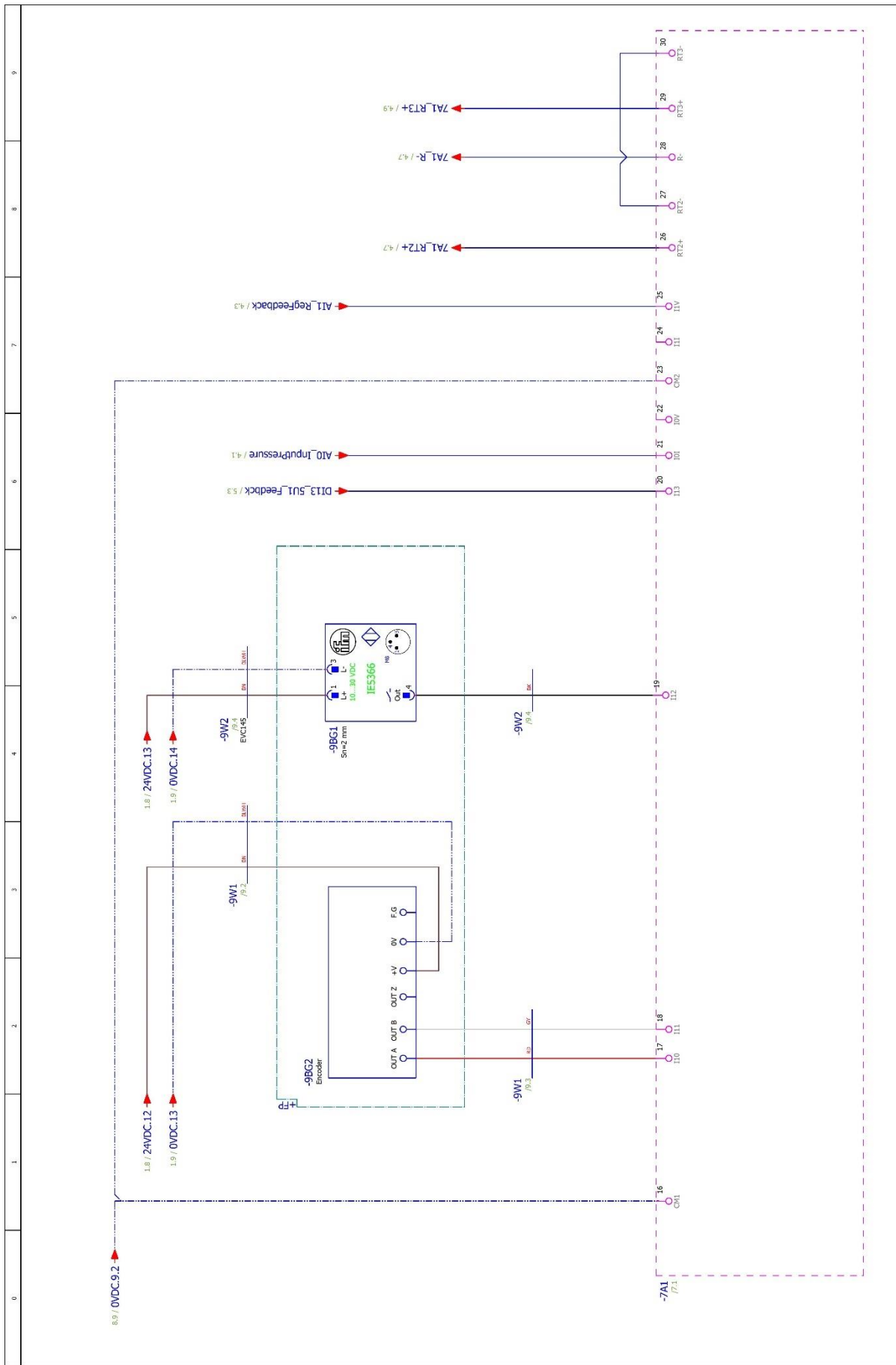

8	Project name: IC-430 blasting machine			PLC_IN/OUT		10
	Schematic version: IC-430-02			IC-430-02		9
Zářez	Datum	7.3.2024				Strana 127/15
	Zprac.	VRNUJ				
	Začet.					
	Přev.					
	Měrov					
	Datum	Návrhová čí.				

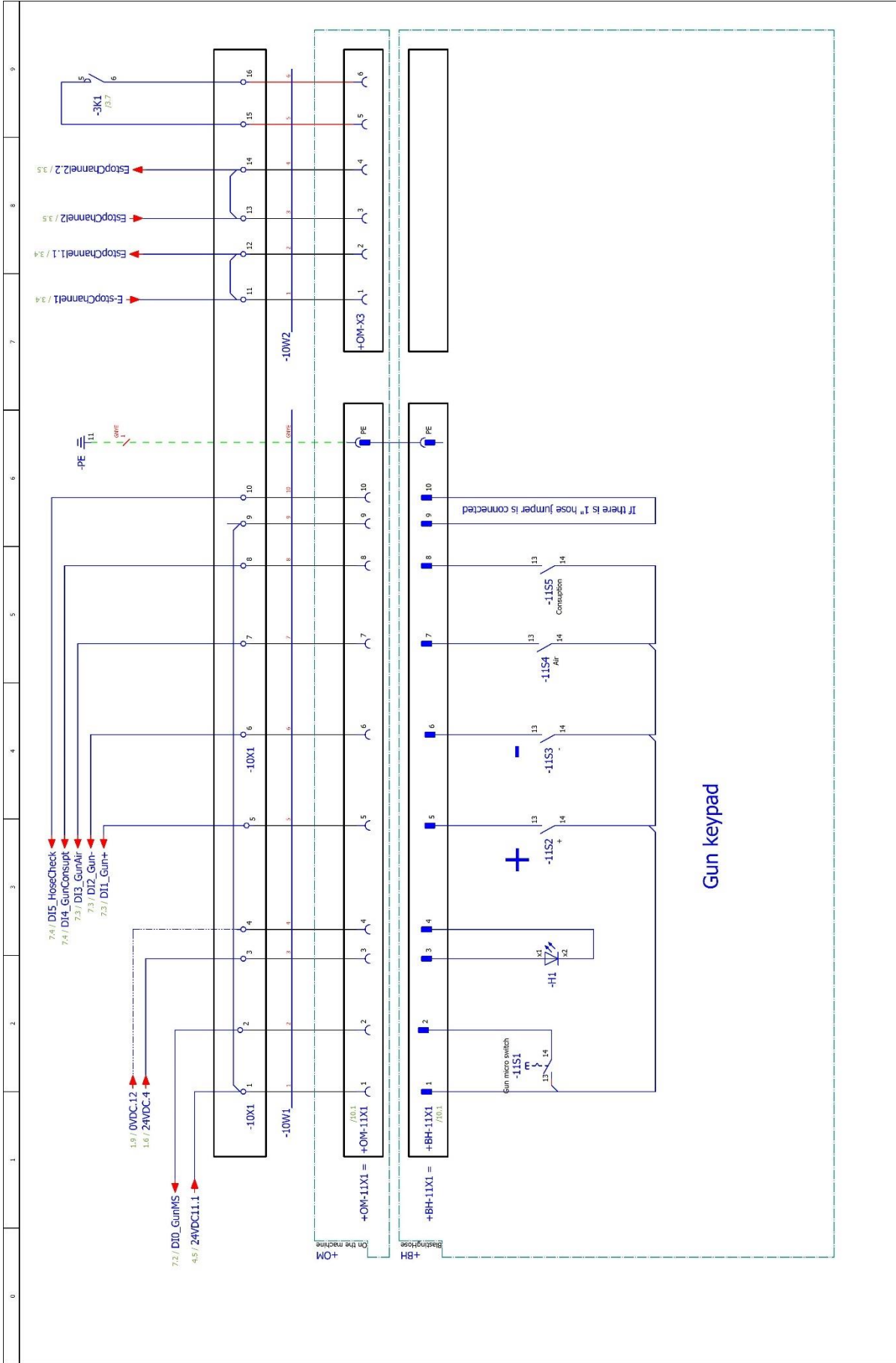

Gun keypad

9		10.a	
Datum	7.3.2024	Project name: IC-430 blasting machine	
Znac.	WNIU	Schematic version: IC-430-02	
Zaczn.		Gun connection	
Pow.		IC-430-02	
Datum		Strona 137/15	
Znac.		List	
Zaczn.		Strona 137/15	

Spare parts list electrical

ID:	Name	Article. No.	Schematic pos.
-X0	Power socket	52033	1.1
-1C1	Power line filter	52030	1.1
-1S1	Main switch button	52061	1.1
-1FA	Circuit breaker	52020	1.1
-1G1	Power supply	52179	1.4
-1F1	5x20mm Cartridge Fuses T10A	N/A	1.5
-1F2	5x20mm Cartridge Fuses T10A	N/A	1.5
-1F3	5x20mm Cartridge Fuses T5A	N/A	1.6
-1F4	5x20mm Cartridge Fuses T8A	N/A	1.6
-1F5	5x20mm Cartridge Fuses T1A	N/A	1.6
-1F6	5x20mm Cartridge Fuses T8A	N/A	1.6
-1F7	5x20mm Cartridge Fuses T8A	N/A	1.6
-2U1	Frequency driver	52016	2.0
-2M1	Feeding system motor	52155	2.1
-2M2	Vibrator motor	52106	2.8
-3KF1	Safety relay	52180	3.1
-3BG1	Safety induction sensor	52186	3.4
-3W1	M12 connector cable	52143	3.4
-3ES1	NC contact	52146	3.5
-3ES1.	LED module	52147	3.5
-3S1	Emergency stop button	52064	3.5
-3K1	Power contactor	52182	3.7
-3K2	Power contactor	52182	3.7
-4BP1	Input pressure sensor	52208	4.1
-4KH1	Proportional valve	51133	4.2
-4BT1,2	Temperature sensor	52209	4.7
-5U1	DC motor driver flow system	52112	5.5
-5U2	DC motor driver scrambler system	52112	5.5
-5M1	Flow system motor	52158	5.9
-5M2	Scrambler system motor	52078	5.9
-6M1	Motor position	52157	6.1
-6BG1	Induction sensor	52210	6.5
-7A1	PLC unit	52211	7.1
-7A2	HMI panel	52189	7.6
-8K1	Interlock relay	52187	8.3
-8K2,3,4	Interlock relay SSR	52212	8.4
-9BG2	Encoder	52213	9.2
-9BG1	Induction sensor	52214	9.4
-MS1	Gun micro switch	52081	4.2

8.3 Pneumatic schematic

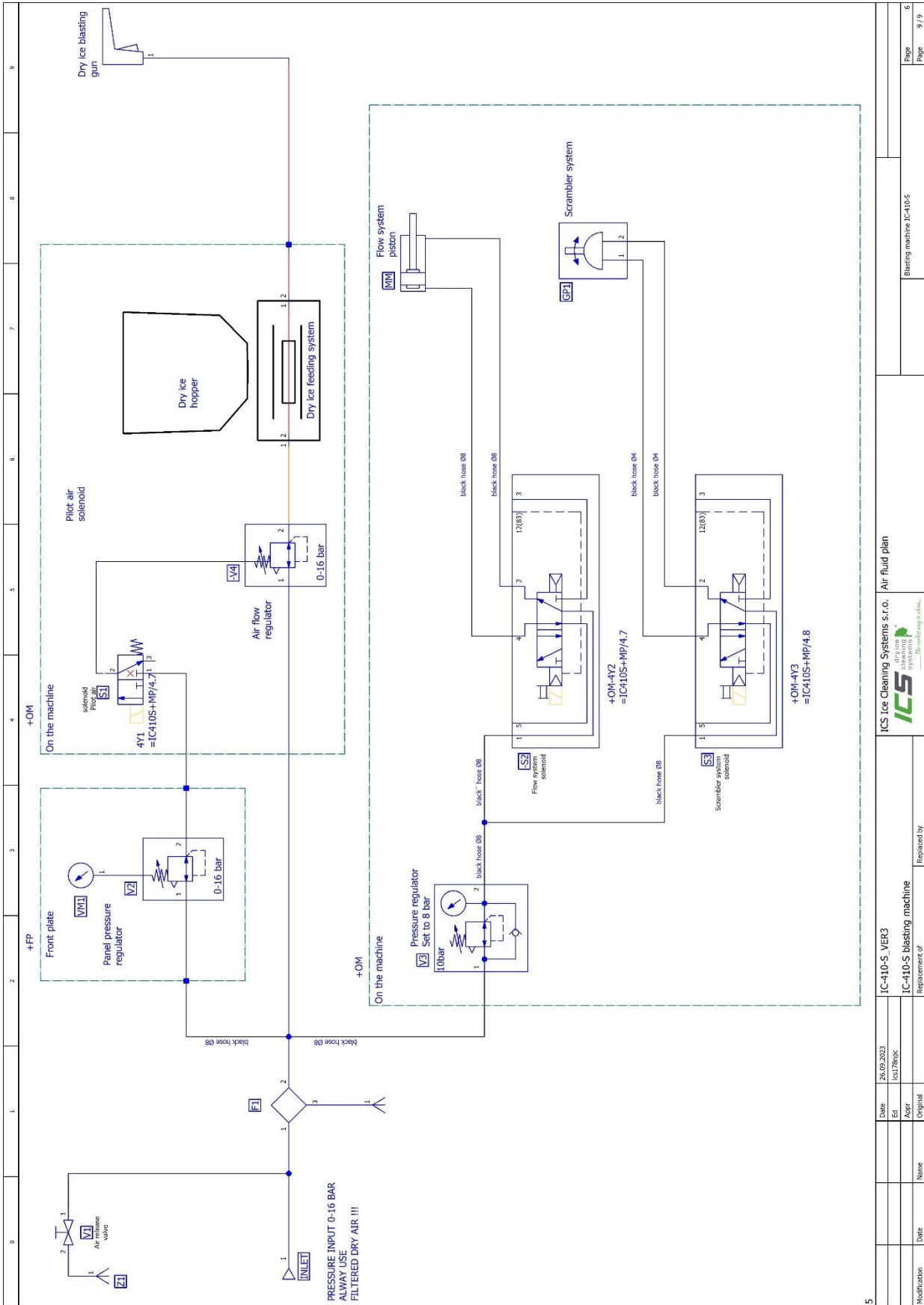

5

Date	26.09.2023	Ed	lci/789pc
Aspr		Original	
Modification		Date	
Replacement of		Replaced by	
IC-410-S, VER3		IC-410-S blasting machine	
ICS Ice Cleaning Systems s.r.o.		Air fluid plan	
dry ice cleaning		Blasting machine IC-410-S	
The world says it's clean.		Page	6
		Page	9 / 9

Spare parts list pneumatic

ID:	Name	Article. No.	Schematic pos.
-F1	Air filter	51011	11.1
-V1	Emergency air release valve	51103	11.0
-V2	Pressure regulator with manometer	51122	11.2
-S1	Flow system solenoid	52019	11.4
-S3	Solenoid pilot air	52188	11.4
-V4	Pilot air regulator	51016	11.4
-MM1	Flow system piston	51072	11.7

9 Liquidation

Disposal of the machine

Have the machine disposed of at an authorized disposal center or at collection center. Before disposing of the machine, it is necessary to remove and separate the following materials and send them to separate collection in accordance with applicable regulations on environmental protection:

- stainless steel parts
- plastic parts
- electrical and electronic components*

[*] Mainly for the disposal of electrical and electronic components, please contact local dealer.



10 Certificates

10.1 Certificate STN EN ISO 9001:2016

ZERTIFIKAT ◆ CERTIFICATE ◆ 認証証書 ◆ СЕРТИФИКАТ ◆ CERTIFICADO ◆ CERTIFICAT





CERTIFICATE

TÜV SÜD Slovakia s.r.o.
Certification Body for Management Systems
 Accredited by SNAS
 Certificate on accreditation No. Q-011
 certifies that



ICS ice cleaning systems s. r. o.
 Robotnícka 2192
 SK – 017 01 Považská Bystrica
 IČO: 45 570 370

has established and applies
 a Quality Management System for

Development, manufacture, sale and service of machines for dry ice blasting. Development, manufacture, sale and service of machines for the production of dry ice. Production of dry ice. Industrial cleaning with dry ice.

An audit was performed, Report No. **1587/30/22/Q/AS/R2**
 Proof has been furnished that the requirements according to

STN EN ISO 9001:2016

are fulfilled. The certificate is valid from **2022-07-28** until **2025-05-18**
 Certificate Registration No. **Q 1587-3**
 Date of recertification audit: **13.06.2022**

Bratislava, 2022-07-28





TÜV SÜD Slovakia s.r.o.
 Certification Body for Management Systems
 Member of Group TÜV SÜD
 Jašíkova 6, 821 03 Bratislava

F-Q-019/2/5

10.2 ES DECLARATION OF CONFORMITY

in compliance with the Machine Directive 2006/42/EC dated 17 May 2006, Annex II A

We hereby declare that the machine specified below complies in its design and construction and in the version marketed by us with the basic safety and health requirements of the EC Directive 2006/42/EC. Any changes to the machine unauthorized by us shall invalidate this declaration.

Product: Dry Ice Blasting Machine

Manuf. Date:

Type: IC-410 / IC-410-S / IC-430

Serial number:

Manufacture:

ICS ice cleaning systems, s.r.o.

Robotnícka 2192

Považská Bystrica, Slovakia

Tel.: +421 42 4261 135

Email: info@ics-dryice.sk

Web: www.ics-dryice.sk

It is declared the compliance with other directives /regulations applicable to the product:

- ✓ DIRECTIVE 2006/42/EC OF THE EUROPEAN PARLIAMENT AND OF THE COUNCIL on machinery, and amending Directive 95/16/EC.
- ✓ DIRECTIVE 2014/35/EU OF THE EUROPEAN PARLIAMENT AND OF THE COUNCIL on the harmonization of the laws of the Member States relating to the making available on the market of electrical equipment designed for use within certain voltage limits.
- ✓ DIRECTIVE 2014/30/EU OF THE EUROPEAN PARLIAMENT AND OF THE COUNCIL on the harmonization of the laws of the Member States relating to electromagnetic compatibility.

Applied harmonized standards in particular:

- ✓ ISO 12 100-1:2011 Safety of machinery — Basic concepts, general principles for design — Part 1: Basic terminology, methodology
- ✓ EN ISO 13849-1:2016 Safety of machinery - Safety-related parts of control systems - Part 1: General principles for design (ISO 13849-1:2015)
- ✓ EN 60204-1:2019 Safety of machinery. Electrical equipment of machines. Part 1: General requirements
- ✓ EN 61439-1:2012 Low-voltage switchgear and control-gear assemblies. Part 1: General rules
- ✓ EN ISO 4414:2011. Pneumatic fluid power — General rules and safety requirements for systems and their components

Representative for the technical documentation: Ing. Ľudovít Bakala PhD., Robotnícka 2192, Považská Bystrica, Slovakia

Place: Považská Bystrica, Slovakia,

Date: 31. 01. 2024

Peter Gabriš
Executive manager

